

SMART APEX

Version 5.0

User's Manual

USER'S MANUAL

SMART APEX User's Manual

This manual covers the SMART APEX software package. To order additional copies of this publication, request the part number shown at the bottom of this page.

© 2000 Bruker AXS Inc. All world rights reserved.

Printed in U.S.A.

Notice

The information in this publication is provided for reference only. All information contained in this publication is believed to be correct and complete. Bruker AXS Inc. shall not be liable for errors contained herein, nor for incidental or consequential damages in conjunction with the furnishing, performance, or use of this material. All product specifications, as well as the information contained in this publication, are subject to change without notice.

This publication may contain or reference information and products protected by copyrights or patents and does not convey any license under the patent rights of Bruker AXS Inc. nor the rights of others. Bruker AXS Inc. does not assume any liabilities arising out of any infringements of patents or other rights of third parties.

Bruker AXS Inc. makes no warranty of any kind with regard to this material, including but not limited to the implied warranties of merchantability and fitness for a particular purpose.

© 2000 Bruker AXS Inc., Madison, Wisconsin 53711 USA, all world rights reserved. Printed in the United States of America. No part of this publication may be stored in a retrieval system, transmitted, or reproduced in any way, including but not limited to photocopy, photography, magnetic, or other record without prior written permission of Bruker AXS Inc.

Address comments to:

Marketing Communications Department
Bruker AXS, Inc.
5465 East Cheryl Parkway
Madison, Wisconsin 53711-5373
USA

Note:

1. Windows NT is a registered trademark of Microsoft.

Table of Contents

1	Introduction	1-1
1.1	SMART APEX Features	1-1
1.2	How to Use This Manual.....	1-1
2	Software Overview	2-1
3	Hardware Overview	3-1
3.1	SMART APEX System Components.....	3-1
3.2	3-axis Goniometer Module with SMART APEX Detector.....	3-3
3.3	Accessories	3-6
4	Data Collection	4-1
4.1	Activate the Video Program.....	4-2
4.2	Activate the SMART Program	4-3
4.3	Optically Align the Sample	4-7
4.4	Unit Cell Determination	4-12
4.5	Data Collection.....	4-14
4.6	Least Squares Refinement	4-15
5	Data Integration	5-1
6	Structure Determination & Refinement	6-1

1 Introduction

1.1 SMART APEX Features

The Bruker AXS SMART APEX system is the newest member the SMART CCD product line of instrumentation for single crystal X-ray diffraction. This system is completely redesigned and features a new CCD detector, based upon a 4K CCD chip. It also incorporates a new goniometer with an enhanced interface, all enclosed in a fail-safe X-ray enclosure system.

From a software and operational viewpoint, the SMART APEX system shares many common features with its predecessors (SMART 1K, SMART 2K, SMART 1000, SMART 2000, SMART 1500, SMART 6000, and SMART 6500). These features are discussed in the SMART Reference Manual. Also, most of the information in the current SMART, SAINT, and ASTRO manuals applies to the SMART APEX system and the other SMART CCD systems.

From a hardware viewpoint, the SMART APEX also shares common hardware components. Other members of this new generation of instruments include the D8 ADVANCE and D8 DISCOVER, and the D8 GADDS systems for general diffraction. Documentation on some of these common hardware and software components is

available in the user's manuals for the D8 family of instruments.

1.2 How to Use This Manual

This manual covers basic tutorial steps to get you started using the SMART APEX X-ray diffractometer system.

The manual leads you step-by-step through an actual data collection and structure determination experiment performed on a typical system. Additional reference is made (where necessary) to related program manuals (SMART, SAINT, ASTRO, and SHELXTL), appendices, other factory documentation, and standard crystallographic reference materials. And special notes are included where new users tend to have problems.

Information is organized in this manual as follows:

- Section 1, Introduction, presents system features and instructions on using this manual.
- Section 2, Software Overview, provides details on the software used with the system.

- Section 3, Hardware Overview, provides details on the system configuration for those not familiar with the equipment. Included is a brief description of each component as well as options available with the system.
- Section 4, Data Collection, describes basic operation of the hardware and software of the SMART APEX system to collect single crystal X-ray diffraction data. Procedural steps are presented in a typical fashion that you would use to analyze an unknown sample.
- Section 5, Data Integration, explains how to convert the raw frame data to a set of integrated intensities that can be used to solve and refine the crystal structure. This section will illustrate use of the SAINTPLUS interface program to carry out integration of a data set previously collected in Section 4.
- Section 6, Structure Determination & Refinement, demonstrates how to use the reduced intensity data to produce a crystal structure. The SHELXTL suite of crystallographic programs will be described.

Examples in this manual use the specimen sample 2-dimethylsulfuranylidene-indan-1, 3-dione (YLID)¹, similar to the crystal provided with your system. By using a similar sample, you can duplicate the procedures described in this manual and obtain similar results to assure your understanding of the SMART programs. (That is, your results should match those outlined in this manual except for minor variations caused by slight differences in specimens or instrument parameters.)

Note: *Before using this manual, ensure that the system is in proper working condition (e.g. the X-ray tube is aligned) and that all software has been properly installed.*

2 Software Overview

The essential software components of the SMART APEX system (located in the Bruker AXS program folder on your Windows NT desktop) are:

SMART program



SMART

This on-line program controls the instrument to collect the experimental data used by the other programs in the system program suite.

SMART program



SMART
off-line

This off-line version performs many data display and manipulation functions but cannot control the instrument.

VIDEO program



video

This program controls the real-time video images from the video camera.

SAINTPLUS
program



SAINTPLUS

This program sets up and carries out the integration process.

SHELXTL
programs



SHELXTL

This program suite produces a crystal structure from the integrated data.

3 Hardware Overview

3.1 SMART APEX System Components

The SMART APEX system (Figure 3-1) consists of the following basic components.

- 3-axis goniometer module with SMART APEX detector (see Section 3.2)
- Radiation safety enclosure with interlocks and warning lights
- D8 controller
- Refrigerated recirculator for SMART APEX detector
- Computer

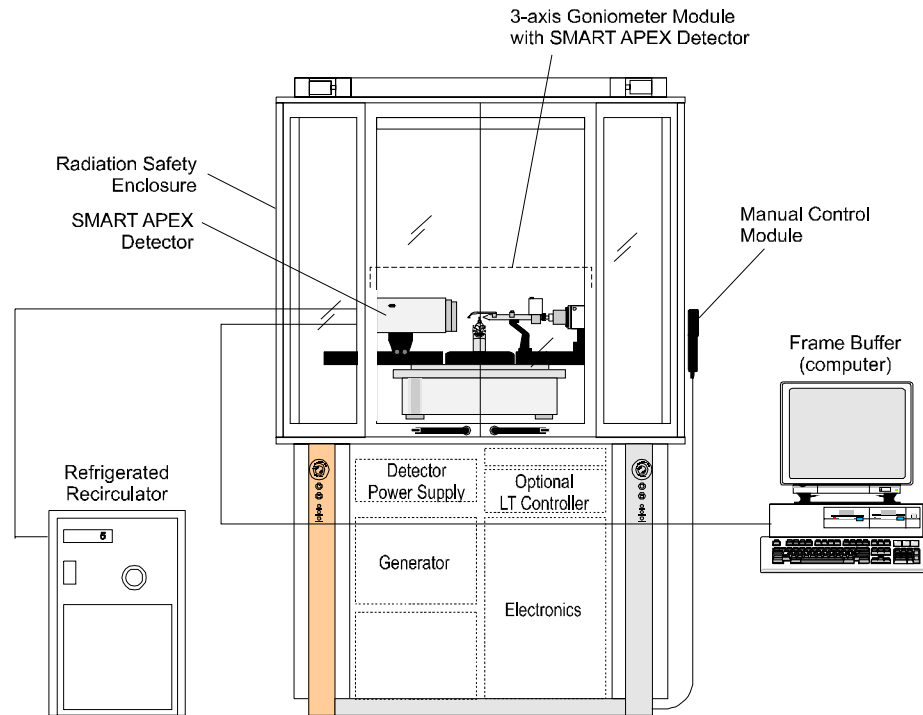

Figure 3-1. SMART APEX system components

Radiation safety enclosure with interlocks and warning lights

A common component of all systems in the D8 family is the radiation safety enclosure. This new design is fully leaded (leaded metal sides and panels, leaded windows) to protect you from stray radiation. The enclosure also includes warning lamps (a government requirement) that alert you when X-rays are being generated. And, as a special feature, the enclosure incorporates interlocks (for both hardware and software)—an automatic system-interruption device that senses when the doors and panels are open and prevents use of the shutter and data collection until you close the doors.

D8 controller

The D8 controller is an electronic module enclosed in the rack behind the front panel of the instrument. It contains all of the electronics and firmware for driving goniometer angles, opening the X-ray shutters, and monitoring other instrument functions, such as safety interlocks, generator status, and detector statuses.

Refrigerated recirculator for SMART APEX detector

The refrigerated recirculator uses Peltier technology to cool the CCD chip to a required -40°C to minimize dark currents.

Computer

Included with the system is a high-speed computer, which is used for control of the experiment, storage of raw frame data, integration of data, and solution and refinement of the structure. The computer uses the Microsoft Windows NT[®] operating system and includes the software described in Section 2. Often the computer is attached to a network of similarly configured computers with access to local and/or network printers.

3.2 3-axis Goniometer Module with SMART APEX Detector

The 3-axis goniometer module and its associated SMART APEX detector comprise the unique hardware of the SMART APEX system. This is the part of the instrument that actually performs the experiment.

Several components comprise the 3-axis goniometer module with SMART APEX detector (Figure 3-2).

- Goniometer with fixed chi (χ) stage
- X-ray source (including shielded X-ray tube, X-ray safety shutter, and graphite crystal monochromator)

- SMART rotary shutter and incident beam collimator (with beam stop)
- SMART APEX detector
- K760 X-ray generator
- Manual control module
- Video camera

Goniometer with fixed chi stage

The standard SMART APEX system uses a horizontally oriented D8 PLATFORM goniometer base (with 2-theta [2θ] and omega [ω] drives) with dovetail tracks for the X-ray source and the detector, and mounting posts for accessories such as the video camera and optional low-temperature attachment. The system also incorporates a fixed chi stage

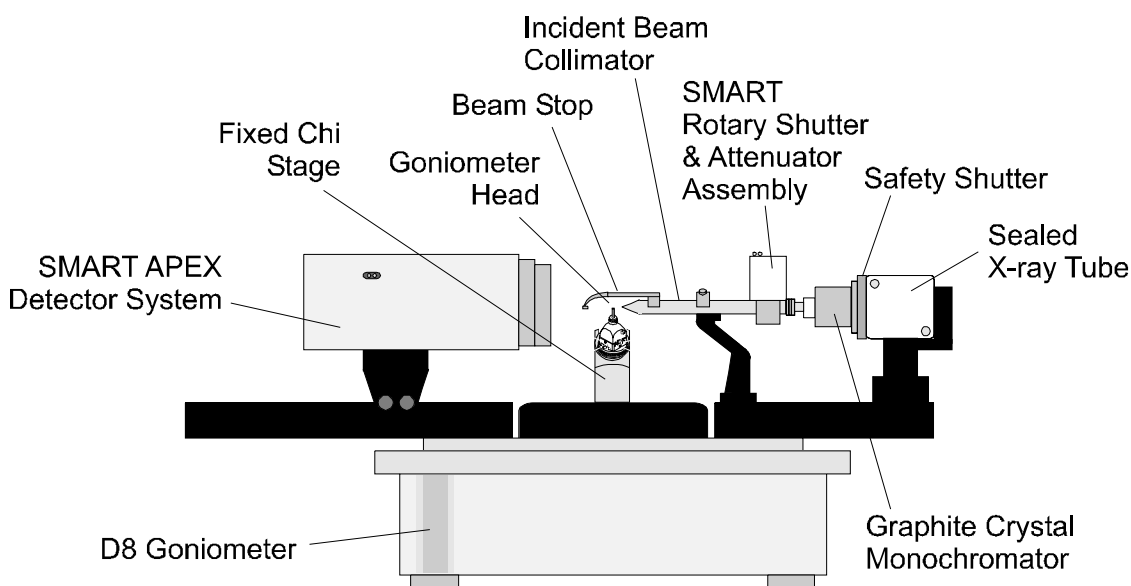

Figure 3-2. SMART APEX & goniometer module instrumentation

with chi angle of approximately 54.74° and a phi drive with 360° rotation.

All four axes (2θ , ω , ϕ , and χ) intersect within a volume of approximately 10 microns. These axes are shown in Figure 3-3.

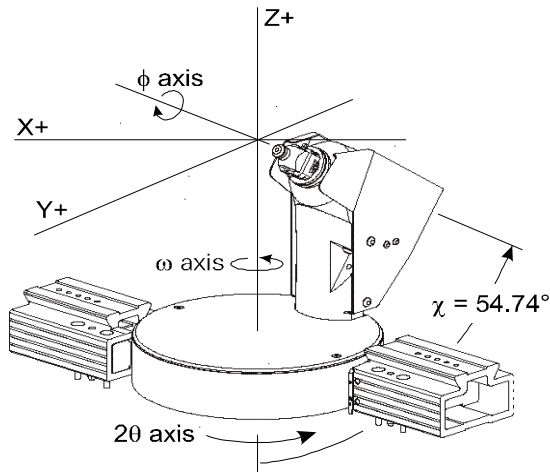

Figure 3-3. Fixed χ , 3-axis goniometer

X-ray source

Three components (Figure 3-2) comprise the X-ray source: a shielded X-ray tube, an X-ray safety shutter, and a graphite crystal monochromator.

The sealed tube X-ray source, with a molybdenum (Mo) target, produces the X-ray beam used by the SMART APEX system.

The X-ray safety shutter is built into the X-ray tube shield. The shutter opens upon initiation of a set of exposures and closes upon the end of collection. Status lamps on the shutter housing indicate when the shutter is open (green) and closed (red). The shutter is also interfaced to the controller and to the safety interlocks.

A tunable graphite crystal monochromator selects only the K_{α} line ($\lambda=0.71073\text{\AA}$) emitted from the Mo X-ray source and passes it down the collimator system.

SMART Rotary Shutter and Collimator

The monochromatic X-ray beam then passes through the labyrinth, the SMART rotary shutter, and the incident beam collimator before striking the specimen.

- The labyrinth is a spring-loaded device, which ensures that the collimator and the SMART shutter are tightly connected to prevent X-ray leakage.
- The SMART shutter is a device which precisely controls the exposure time for each frame during data collection. Its

status lamps indicate when the shutter is open (ON) and closed (OFF). This assembly also houses an automatic attenuator.

- The incident collimator is equipped with pinholes at both front (near crystal) and rear (near source). These pinholes help to define the size and shape of the incident X-ray beam that strikes the specimen. You will normally use a collimator with 0.5 mm pinholes. (Collimators are available in a variety of sizes, depending on your application.)
- The beam stop (a hook-like assembly attached to the collimator) catches the remainder of the direct beam after it has passed the specimen. The beam stop has been aligned to minimize scattered X-rays and to prevent the direct beam from hitting the detector.

The entire collimator assembly is supported by a collimator support assembly, which has been precisely aligned to guarantee that the X-ray beam passes through the center of the goniometer.

SMART APEX detector

The SMART APEX detector is specific to this system. It is mounted on a 2θ dovetail track. The track has a scale that is calibrated to indicate the distance from the crystal to the phosphor window (a typical distance is 6 cm). Status lamps on the detector housing indicate when the detector is on (green) and off (red).

K760 X-ray generator

The K760 X-ray generator is a high-frequency, solid-state X-ray generator, which provides a stable source of power for operations up to 60 kilovolts (kV) and 50 milliamps (mA). For the SMART APEX system, power settings should never exceed the maximum power rating of the X-ray tube. (Typical maximum power settings for the SMART APEX system with a normal focus tube are 50 kV, 40 mA. The kV setting should not exceed 50 kV.) This generator is interfaced to the controller, and the power settings may be adjusted either from front panel buttons or from within the SMART software.

Manual control module

The manual control module is a remote device that you will use in certain operations to manually drive angles (particularly in optical alignment of a specimen). The module is physically the same as in other D8 systems but has a different keypad and functions. In this application, you will use only the first three rows of buttons and the AXIS PRINT button.

Video camera

The video camera, an essential part of the system, allows you to visualize the crystal to optically align it in the X-ray beam and to measure the crystal dimensions and index crystal faces. The camera is interfaced to the computer and is operated through the VIDEO program. The camera is mounted in the accessories track of the goniometer base.

3.3 Accessories

Various devices can be mounted in an accessories track on the goniometer base. These include an optional low-temperature attachment.

4 Data Collection

We are now ready to begin actual operation of the instrument, using the YLID test crystal (mentioned in section 1). We assume that your system manager has set up the system properly and that all system default parameters have been set appropriately.

At this time, double click the BrukerAXS Programs icon on the Windows NT desktop (Figure 4-1).

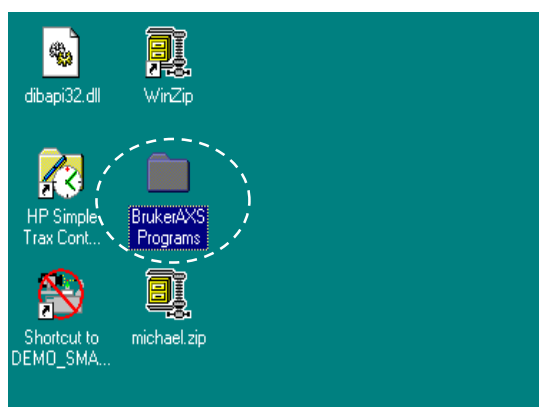

Figure 4-1. Bruker AXS programs icon on desktop

The BrukerAXS Programs window appears (Figure 4-2), containing icons for the Bruker AXS Program modules described in Section 2.



Figure 4-2. BrukerAXS programs window

4.1 Activate the Video Program

Before starting the SMART program, you must first activate the video camera as follows:

1. Double-click the Video (binoculars) icon (recall Figure 4-2) to start the Video program and display the main window (Figure 4-3).

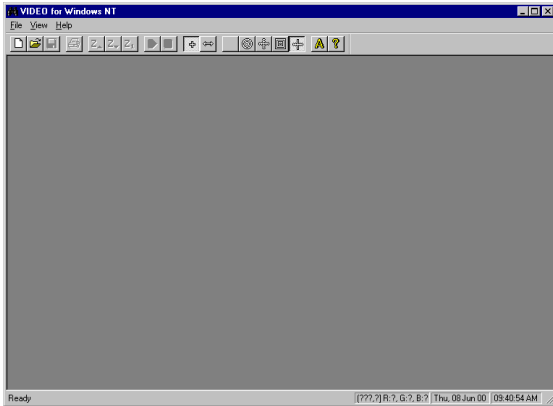

Figure 4-3. Video program's main window

2. Click File > New Image to open a new file (Figure 4-4).

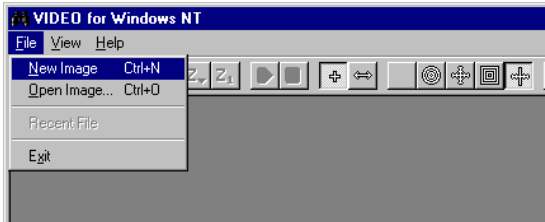

Figure 4-4. Create new video image

3. Then press the green arrow button in the toolbox to start the video frame grabber (Figure 4-5).

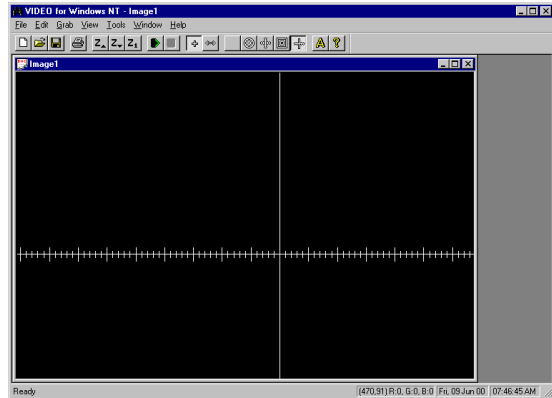

Figure 4-5. Start video frame grabber

The video camera is now ready for later use. Continue now to the SMART Program section of this manual.

4.2 Activate the SMART Program

Activate the SMART program as follows:

1. Double-click the SMART (goniometer) icon to start the SMART program. SMART establishes communication with the D8 controller, the SMART APEX detector, and the X-ray generator. Then it displays its main screen without unit cell information (Figure 4-6).

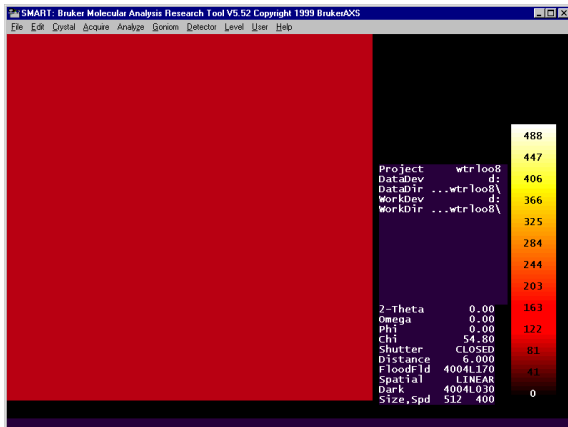

Figure 4-6. Main screen without unit cell information

Then SMART reminds you where you last worked and displays the next message (Figure 4-7).

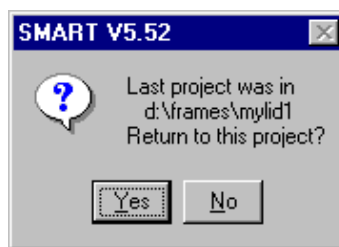

Figure 4-7. Return to project

2. Press the Yes button (normal response). The program then informs you that it has changed directories and asks for confirmation to continue (Figure 4-8).



Figure 4-8. Confirmation of current directory

- Press OK (normal response). The program then communicates with the instrument, then loads the calibration files and parameters from the previous project (Figure 4-9).

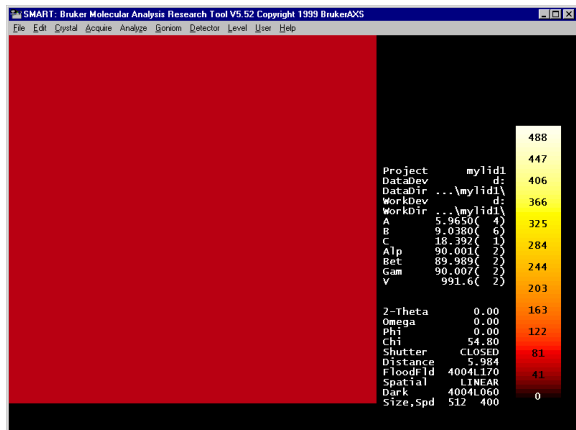

Figure 4-9. Screen showing data from previous project

Note: While presenting data (handshaking), the menu headings appear grayed (inactive). Once all data has been displayed (handshaking finished), the menu headings return to black (active).

- Click Crystal > New Project to start a new project. A new project options window appears (Figure 4-10).

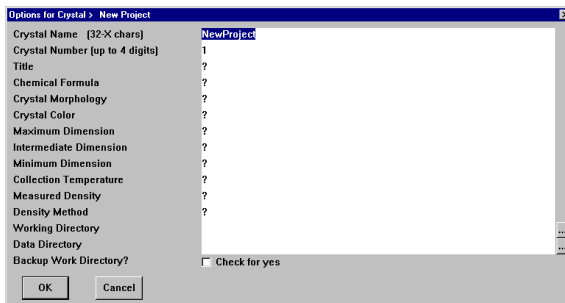

Figure 4-10. New project options window after entering information

- Fill in all available information as shown (Figure 4-11). Note that you must specify a Project Name (lines 1 and 2) and a Working Directory and a Data Directory (which may be the same). You should also enter additional information specific to your specimen so that it will appear in the final structure report. When you are finished, click OK.

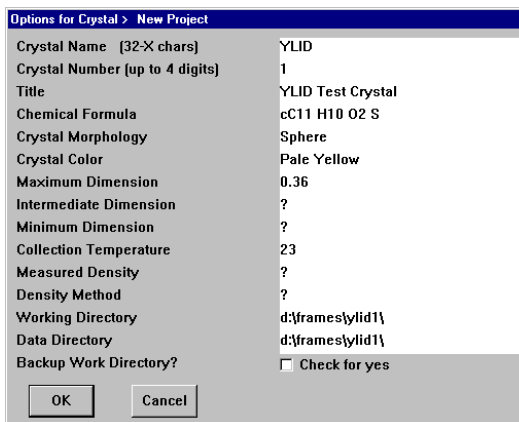

Figure 4-11. Options window

The following save message appears (Figure 4-12).

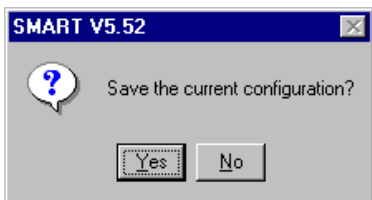

Figure 4-12. Save the current configuration

6. Press Yes. Another message prompts you to create the new directory (Figure 4-13). The message will appear twice if the working directory and the data directory are not the same.

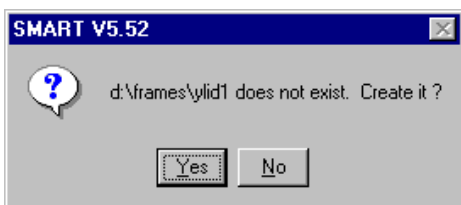

Figure 4-13. Create the new directory

7. Click Yes (normal response). SMART then asks you to load the system default settings (Figure 4-14).

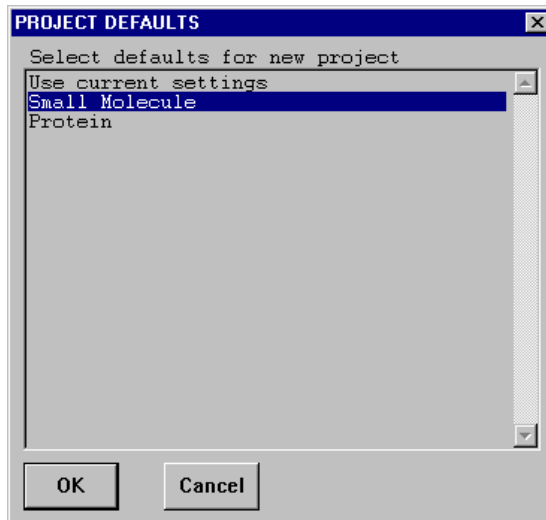

Figure 4-14. Project defaults

8. Select Small Molecule, then press OK. SMART loads the system defaults and displays a SMART screen. This screen will contain the sample-to-detector plane distance, the current goniometer angle settings, current dark and flood files, and information concerning your project and its working and data directories. No unit cell information displays. (Figure 4-15.)

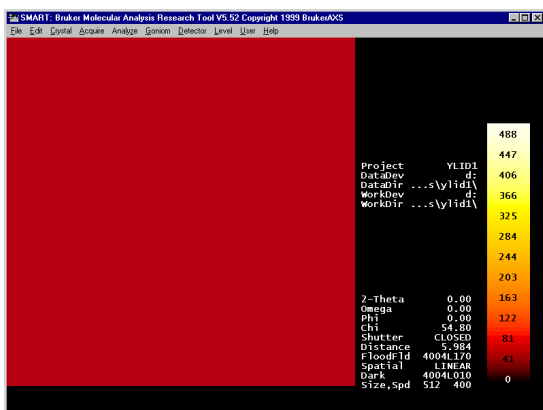

Figure 4-15. SMART screen with loaded data

9. Click Level > Level1 (Figure 4-16). This level has a minimum number of options for routine problems, such as YLID, and will be used for this tutorial experiment. Level2 has more crystallography options required for special problems. Level3 is designed for use by a system manager only.

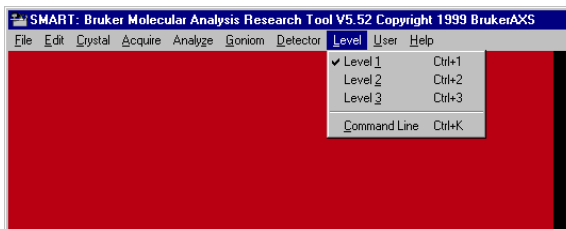

Figure 4-16. Level menu

- Click Goniom > Zero to drive all angles to zero, and check the goniometer scales to ensure that all angles read zero. The following drive message appears (Figure 4-17).

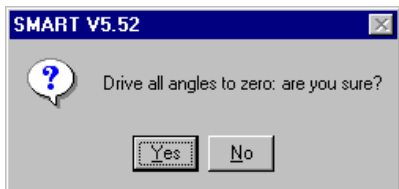

Figure 4-17. Drive all angles to zero

The system is now ready for you to begin the experiment.

CAUTION: Use extreme care when handling the goniometer head to prevent damage to your expensive sample on the end of the small glass fiber.

- Carefully remove from its case the goniometer head containing the YLID test crystal.
- Place the goniometer head onto its base on the phi (ϕ) drive, aligning the head's key slot with the key (pin) in the base. Snugly screw the head's collar to the base such that the head does not move, but do not overtighten it.

Note: At $\phi=0^\circ$, the key on the mounting base of the goniometer head will be at the 12:00 position.

- Click Crystal > Generator to check the X-ray power. The Goniometer /Generator Options panel appears (Figure 4-18).

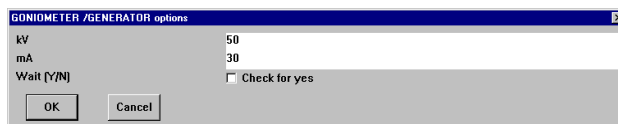

Figure 4-18. Goniometer /Generator Options panel

- Set appropriate values for kilovolts (kV) and milliamps (mA). For this experiment, we want 50 kV and 30 mA. Click OK to program these new settings.

4.3 Optically Align the Sample

To obtain accurate unit cell dimensions and to collect good quality data, you must align the center of the sample with the center of the X-ray beam and maintain the alignment for the entire experiment. We assume that your video camera has been aligned so that the crosshairs of the video camera coincide with the center of the goniometer and the center of the X-ray beam.

Align the sample as follows:

1. Click Crystal > Evaluate to begin the alignment of the sample in the center of the X-ray beam.

The alignment process combines optical alignment steps with rotational photo steps. The menu bar at the top of the SMART screen remains gray (Figure 4-19) until you complete the optical alignment step and exit by pressing the ESC key.

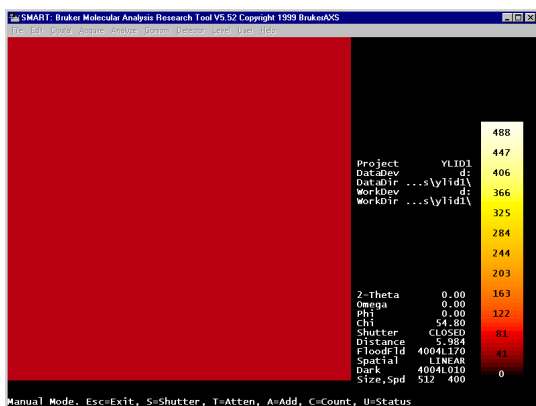

Figure 4-19. Grayed SMART screen menu bar during optical alignment

During the first stage (optical alignment), you will control the instrument from the manual control module (Figure 4-20) using buttons A and B.

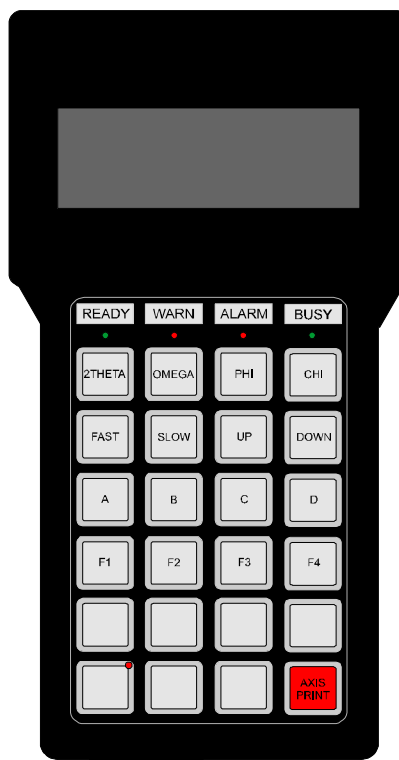

Figure 4-20. Manual control module

Also during optical alignment, you will adjust the goniometer head at screw locations shown in Figure 4-21. Use the goniometer wrench to unlock the axis adjustment locks and later lock them. Use the other end of the wrench to turn the adjustment screws.

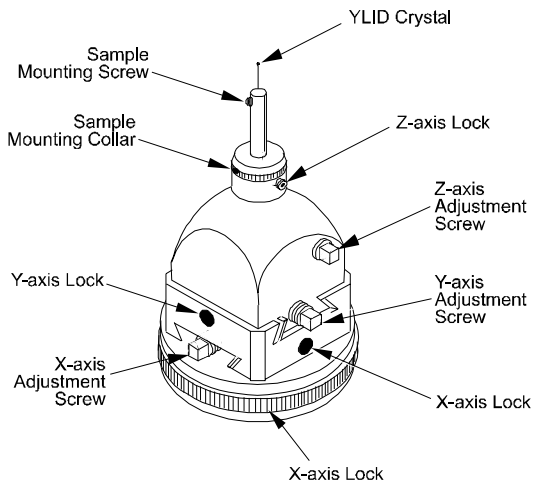

Figure 4-21. Goniometer head adjustment locations

2. Click on the Video window to display the real-time image of the crystal (Figure 4-22).

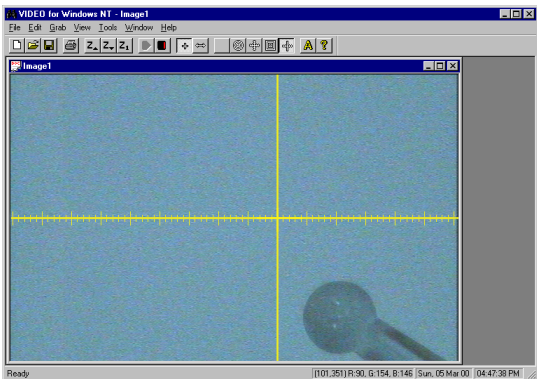

Figure 4-22. Real-time image of the crystal

3. Press the A button on the manual control module to drive the goniometer angles to the base position ($2\theta = -30^\circ$, $\omega = -30^\circ$) and $\phi = 0^\circ$ for optical alignment.

Note: If you have difficulty seeing the image of the crystal, you may want to better illuminate the sample with a high-intensity lamp and/or temporarily place a light-colored piece of paper on the front of the detector.

4. Adjust the goniometer head's Z-axis adjustment screw (recall Figure 4-21) until the crystal is near the crosshairs intersection on the video screen (Figure 4-23).

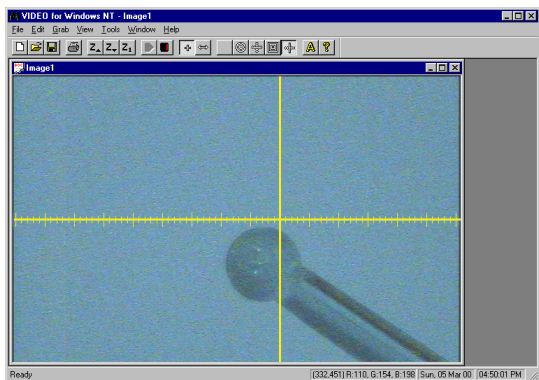

Figure 4-23. Crystal near the crosshairs intersection

- Adjust the goniometer head's X-axis adjustment screw to center the crystal on the crosshairs intersection (Figure 4-24).



Figure 4-24. Crystal centered on crosshairs ($\phi = 0^\circ$)

- Press the A button again to rotate the phi by 180° and to verify that you have correctly centered the sample at both $\phi = 0^\circ$ and $\phi = 180^\circ$. (Do not be concerned if the crystal moves away from its center as it rotates; you have not yet adjusted the Y axis.)

Note: Repeat this process as many times as necessary. Each time you press the A button, the phi angle will rotate between 0° and 180° .

- Press the B button to rotate the phi angle to 90° for adjustment of the Y axis (Fig 4-25).



Figure 4-25. Crystal oriented for Y-axis adjustment

- Adjust the goniometer head's Y-axis adjustment screw (Figure 4-19) to center the crystal on the crosshairs intersection (Figure 4-26).

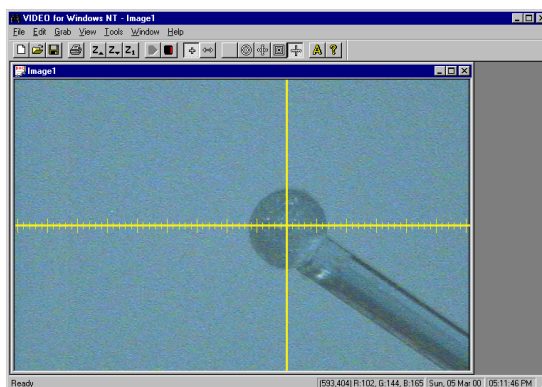

Figure 4-26. Crystal centered on crosshairs ($\phi = 90^\circ$)

- Press the B button again to rotate the phi angle to 270° and to verify that you have correctly centered the sample at both $\phi = 90^\circ$ and $\phi = 270^\circ$.

Note: Repeat this process as many times as necessary. Each time you press the B button, the phi angle will rotate between 90° and 270°.

The center-of-mass of a properly aligned specimen should stay in the same place with respect to the center of the crosshairs in all angle settings.

Note: If the video camera has become misaligned, the center of the crosshairs may need to be adjusted by your system manager.

- Cycle between the two positions of both A and B one last time to ensure that the crystal remains centered in all positions.
- After the alignment has been completed using A and B positions, you should verify the alignment by using the C and D buttons in a similar manner.
- When you have completed the optical alignment steps, remove any paper you might have placed on the detector face and close the doors of the enclosure.
- Click on the SMART program window, then press the ESC key to exit the optical alignment stage. SMART then prompts for a rotation photograph (Figure 4-27).

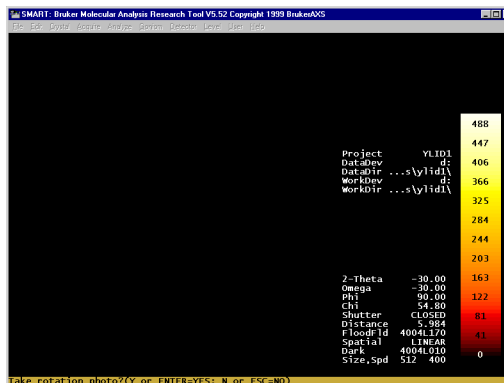

Figure 4-27. Prompt for a rotation photograph

- Press Y (normal response). SMART will then perform a 60-second rotation photo. During this time, phi data on the screen will be highlighted and the shutter data will read: OPEN. Upon completion of the photo, the image frame will display on the screen (Figure 4-28).

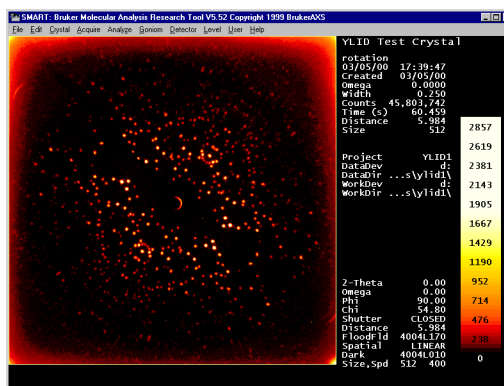

Figure 4-28. Image frame following 60-second rotation

At this time, proceed to Unit Cell Determination.

4.4 Unit Cell Determination

Perform a unit cell determination as follows:

1. From the SMART program, click Crystal > Unit Cell. The following message appears, asking you to verify that the distance and beam center are correct (Figure 4-29).

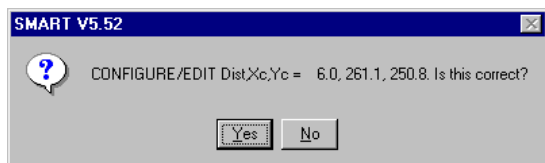

Figure 4-29. Distance and beam center verification

2. Ensure that the distance shown on the detector scale agrees with the value shown on the screen. Then press Yes. SMART then displays a set of default values for unit-cell determination and asks you to confirm them (Figure 4-30).

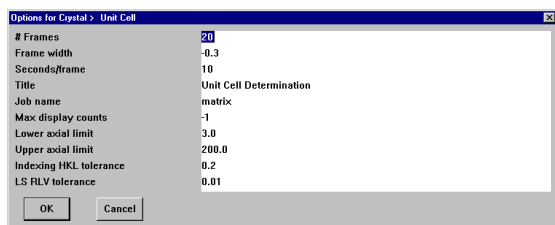

Figure 4-30. Set of default values for unit-cell determination

3. Press OK (as these values are appropriate for this crystal). The program then collects three sets of 20 frames called MATRIX0, MATRIX1, and MATRIX2 (Figure 4-31).

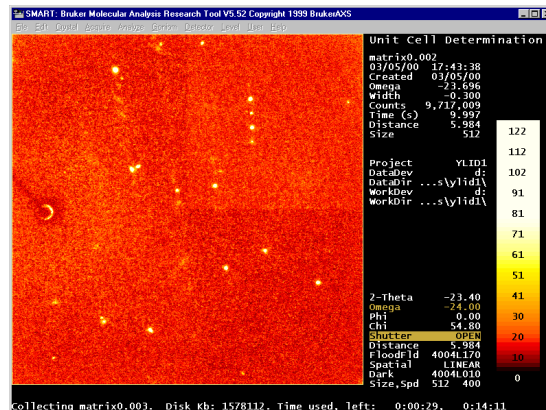

Figure 4-31. Frame collection (MATRIX0, MATRIX1, and MATRIX2)

When all frames have been collected, SMART performs the steps of thresholding, indexing, Bravais lattice determination, and least-squares refinement of cell constants. The YLID test crystal has an orthorhombic primitive unit cell, as shown in Figure 4-32.

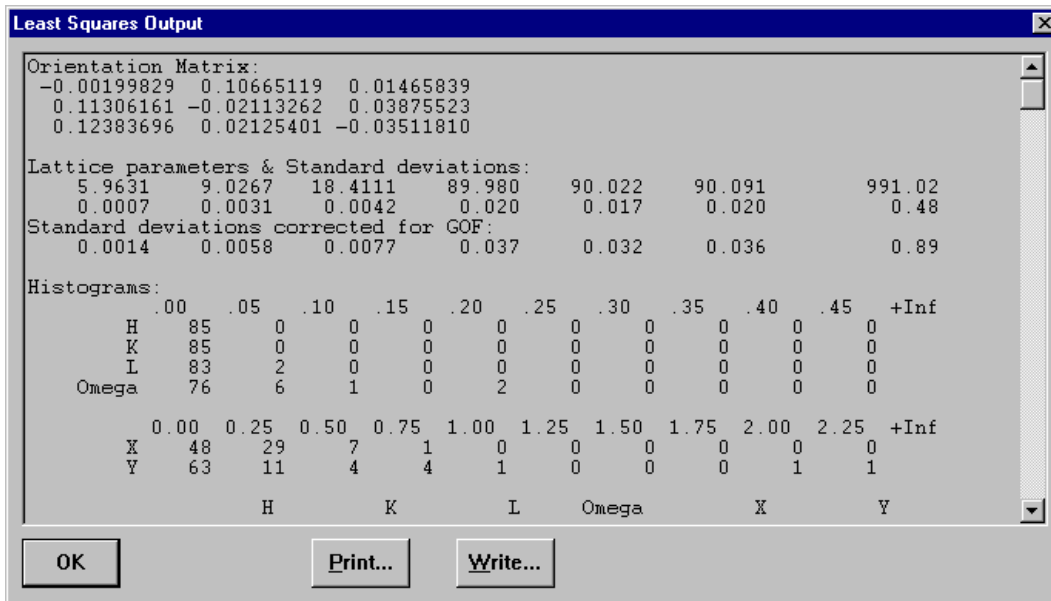

Figure 4-32. Least-squares output

The YLID test crystal should have an orthorhombic Primitive cell with approximate cell dimensions of $a=5.95\text{\AA}$, $b=9.03\text{\AA}$, $c=18.38\text{\AA}$, and $\alpha=\beta=\gamma=90^\circ$.

You are now ready to collect data.

4.5 Data Collection

Perform data collection as follows:

1. From the SMART program, click Acquire > Hemisphere. SMART displays the data collection options (Figure 4-33).

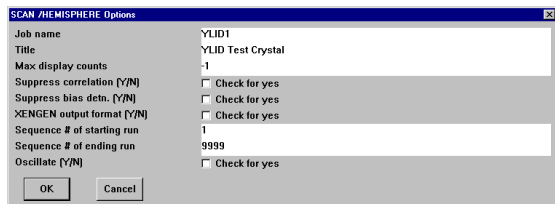

Figure 4-33. Data collection options

2. Enter the job name, then press OK to begin data collection (Figure 4-34).

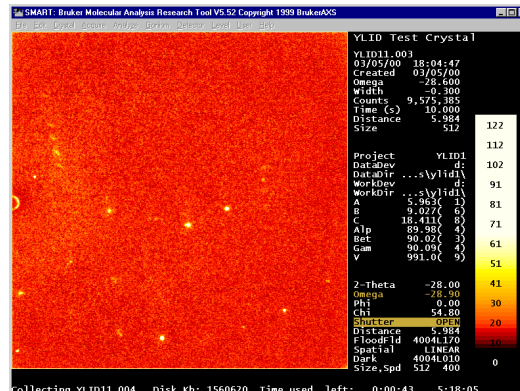

Figure 4-34. Data collection

The hemisphere data set specified in this example will require about four hours to collect. Upon completion of data collection, the following message displays (Figure 4-35).



Figure 4-35. No more runs in Edit/Runs array

3. Press OK. Then click Goniom > Zero to drive the goniometer angles to zero. The following drive message appears (Figure 4-36).

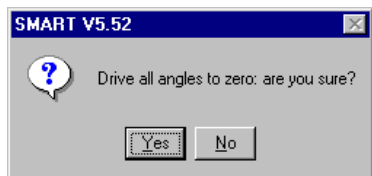

Figure 4-36. Drive all angles to zero

4. Press Yes.

4.6 Least Squares Refinement

Before leaving the SMART program, you might want to improve the orientation matrix that will be used for integration. Do so as follows:

1. Click Crystal > LS to further perform the least squares refinement. The Least Squares Options window appears. (Figure 4-37).

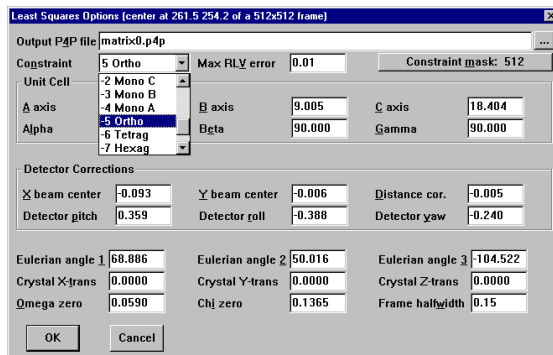

Figure 4-37. Least Squares Options window

The YLID crystal is orthorhombic and, therefore, the alpha, beta, and gamma angles should be 90°. You may constrain them to be so with the Constraint field of the Least Squares Options window.

2. Change the Constraint field to Ortho and press OK. The program may remove a few of the poorest fitting reflections. The following removal message appears (Figure 4-38).

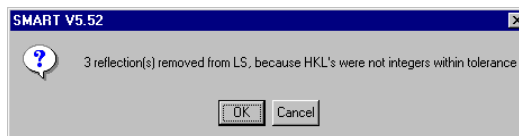

Figure 4-38. 3 reflections removed from LS

- Press OK. SMART displays a Least Squares Output window showing, among other data, a histogram for the reflections and the unit cell parameters with errors (Figure 4-39).

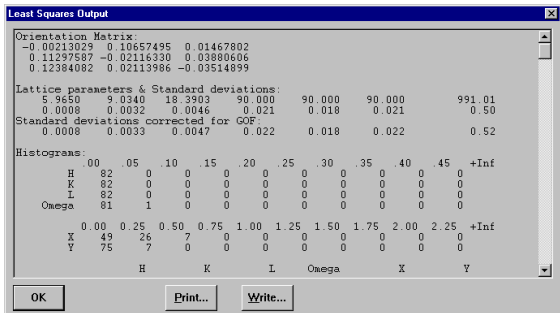

Figure 4-39. Histogram for reflections and unit cell parameters with errors

If the refinement process was done correctly, the histogram will show zeros in all columns except the first.

- Press OK. A message asking you to overwrite the default file for refined unit cell parameters (matrix0.p4p) appears (Figure 4-40).

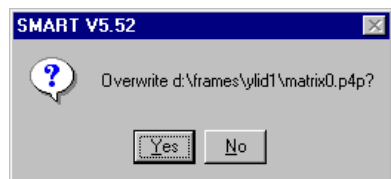

Figure 4-40. Overwrite default matrix0.p4p file

- Press Yes. You have now completed the least-squares refinement process.

- Click File > Exit to leave the SMART program. The exit message appears (Figure 4-41).

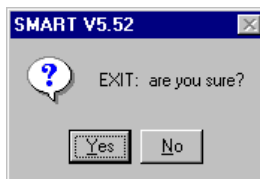

Figure 4-41

- Press Yes. The save message appears (Figure 4-42).

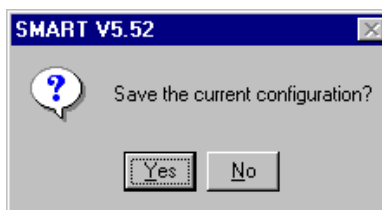

Figure 4-42

- Press Yes.

This completes the data collection process.

5 Data Integration

Before the data can be used to solve and refine the crystal structure of the YLID, you must convert the frame data produced by SMART to a set of integrated intensities. To do so, you must run the SAINT program. SAINTPLUS helps you set up the SAINT input parameters.

Integrate the data set as follows:

1. Click the SAINTPLUS icon in the Bruker AXS programs folder to start that program menu (recall Figure 4-1).
2. Click Project > New to create a new project (Figure 5-1).

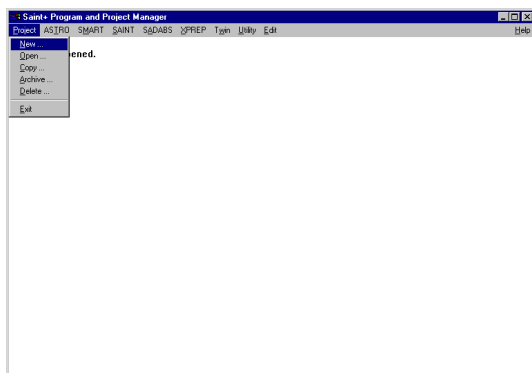

Figure 5-1. Create a new project

3. Assign a name to the project. Then use the built-in explorer to locate the data directory used by the SMART program (Figure 5-2).

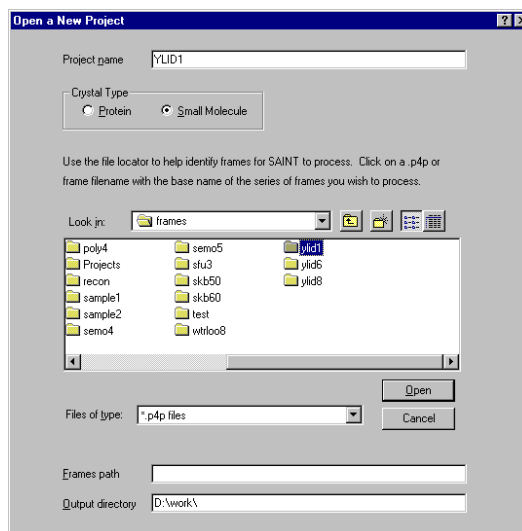

Figure 5-2. Assign a name and locate the directory

- Select one of the .P4P files (i.e., not a MATRIX file) from the full data set. Then click open (Figure 5-3).

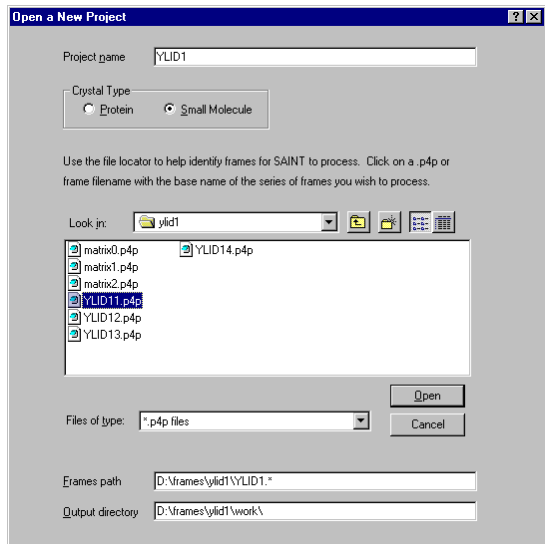

Figure 5-3. Select a .P4P file

A summary window appears, showing the name and directories used by the project (Figure 5-4).

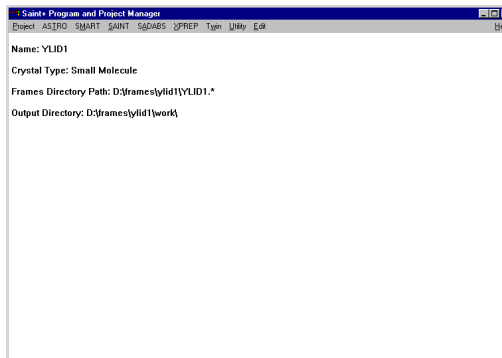

Figure 5-4. SAINTPLUS project summary window

- Click SAINT > Initialize to initialize the project.
- Click SAINT > Execute.

An input box appears, summarizing the information that SAINTPLUS has determined (Figure 5-5).

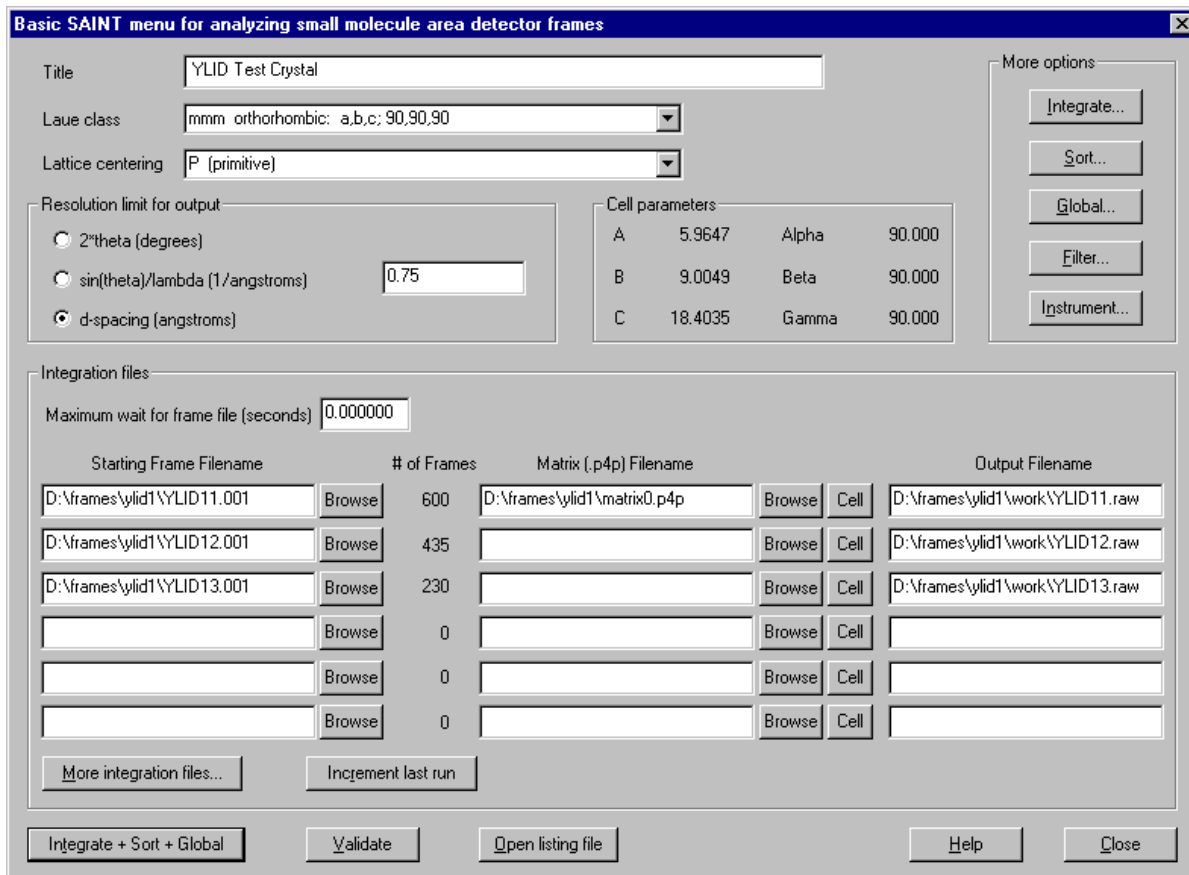

Figure 5-5. Information that SAINTPLUS has determined

7. Check to see that the values for your data set match those shown. Change any parameters that do not match. In particular, change the input file to matrix0.p4p for the first run, and delete the .p4p filename for subsequent runs. A resolution of 0.75 (d-spacing) should be

used for a sample-to-detector plane distance of 6.00 cm.

8. Click the Integrate button to display the parameters for integration (Figure 5-6). Check to see that the values for your data set match those shown. Change any parameters that do not match.

The screenshot shows the 'Integrate' dialog box with the following settings:

- Reflection size:** X size (degrees) 0.60000, Y size (degrees) 0.60000, Z size (degrees) 0.30000. Use narrow frame algorithm, Enable box size optimization.
- Decay correction:** Apply decay correction.
- More integration options:** Integration Files..., Advanced Integrate...
- Periodic orientation matrix updating:** Enable periodic updating, Periodic updating frequency 100. **Constraints:** Constrain integration by Laue class, Crystal system Orthorhombic (a,b,c; 90,90,90). Detector center X, Detector center Y, Detector pitch, Detector roll, Detector yaw, Detector distance, Unit cell axes, Unit cell angles, Goniometer zeros, Crystal translations.
- Continuous crystal and detector orientation updating:** Enable continuous updating, Damping factor λ : $P' = P + \frac{P-P}{4\lambda W X}$ 1.000000.
- Post-integration global (all data) refinement:** Enable global least squares refinement, Limit on number of reflections to refine 9999. **Constraints:** Constrain refinement by Laue class, Crystal system Orthorhombic (a,b,c; 90,90,90). Detector center X, Detector center Y, Detector pitch, Detector roll, Detector yaw, Detector distance, Unit cell axes, Unit cell angles, Goniometer zeros, Crystal translations.
- Post-integration sorting and filtering:** Sort by Laue class, Point group mmm orthorhombic, Minimum I/sigma(I) to output -3.000000, Enable correlation filter.

Buttons at the bottom: Integrate + Sort + Global, Validate, Open listing file, Help, Close.

Figure 5-6. Integrate input window

- Click the Advanced Integrate button to display the Advanced Integrate input box (Figure 5-7). Compare the values for your data set with those shown. Make required changes.

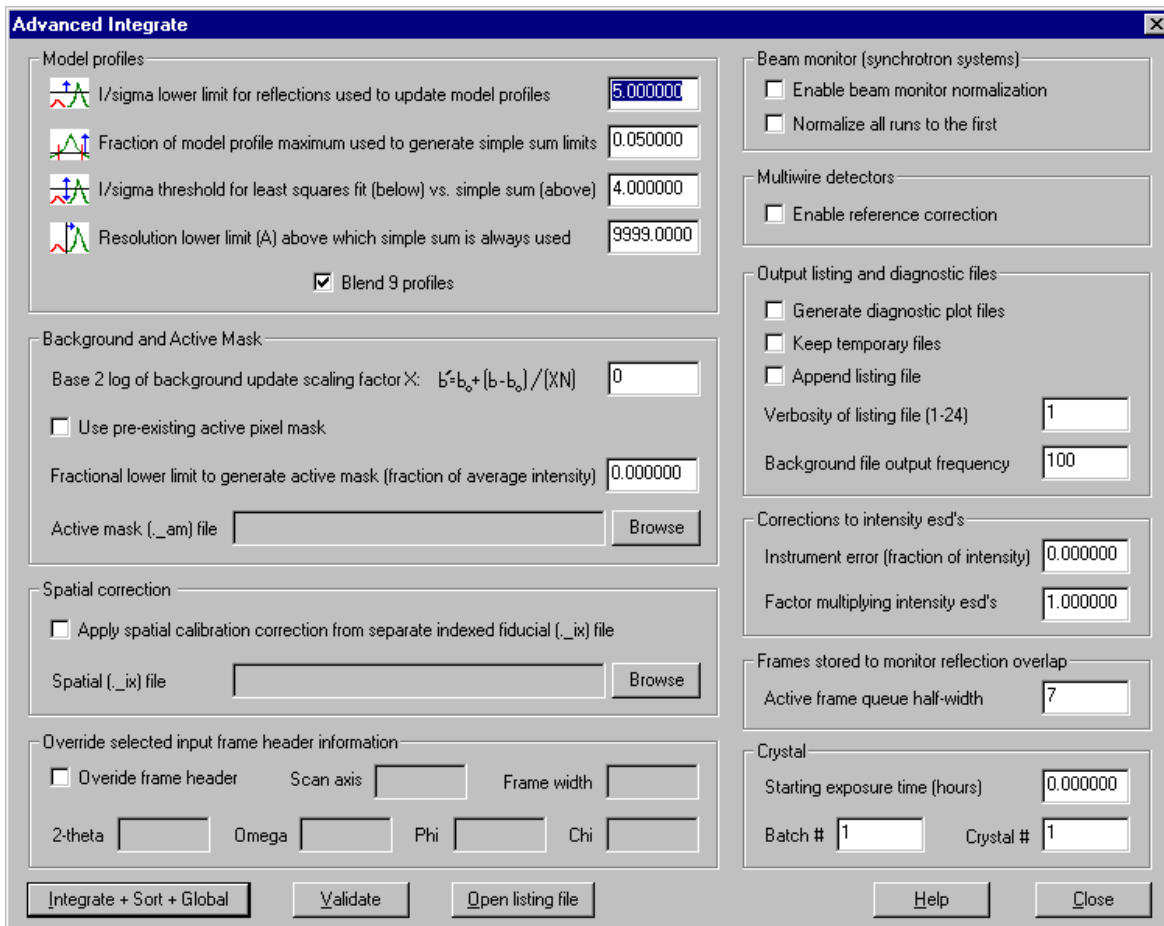
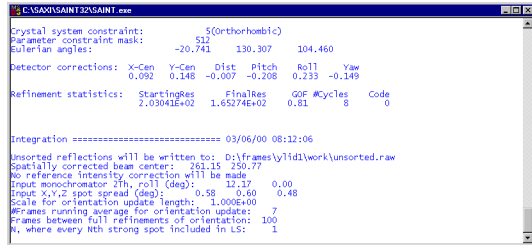

Figure 5-7. Advanced Integrate input window

10. Click the Integrate + Sort + Global button to execute the SAINT program. The integration process takes about 15 minutes, displaying data as shown (Figure 5-8).



```

C:\SAXIS\SAINT 32\SAINT.exe
Crystal system constraint:          5(Orthorhombic)
Parameter constraint mask:         512
Eulerian angles:                   -20.741   130.307   104.460
Detector corrections: X-Cen Y-Cen Dist Pitch Roll Yaw
                       0.092  0.148  -0.007  -0.208  0.233  -0.149
Refinement statistics: StartingRes FinalRes GOF #Cycles Code
                       2.03041E+02  1.65274E+02  0.61      8      0

Integration ===== 03/06/00 08:12:06
Unsorted reflections will be written to: D:\frames\ylidi\work\unsorted.raw
Spatially corrected beam center:    361.15  250.77
No reference intensity correction will be made
Input monochromator 2 $\theta$ , roll (deg):  12.12  0.00
Input X,Y,Z spot spread (deg):      0.58  0.60  0.48
Scale for orientation update length: 1.000E+00
#Frames running average for orientation updates: 7
Frames between full refinements of orientation: 100
N, where every Nth strong spot included in LS: 1

```

Figure 5-8. Integration data

11. When the integration process has finished, the results of the global refinement of unit cell parameters display (Figure 5-9).

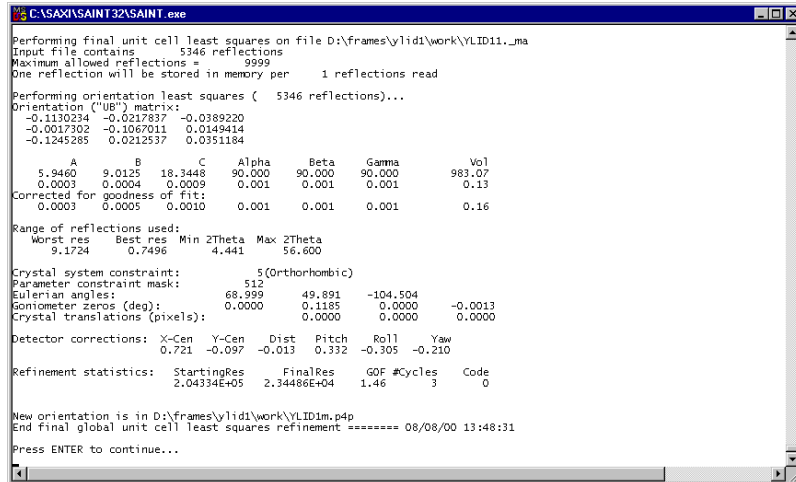

```

C:\SAXIS\SAINT 32\SAINT.exe
Performing final unit cell least squares on file D:\frames\ylidi\work\YLID11...ma
Input file contains 5346 reflections
Maximum allowed reflections = 9999
One reflection will be stored in memory per 1 reflections read

Performing orientation least squares ( 5346 reflections)...
Orientation ("UB") matrix:
-0.1130234  -0.0217837  -0.0389220
-0.0017302  -0.1067011  0.0149414
-0.1245285  0.0212537  0.0351184

      A      B      C      Alpha      Beta      Gamma      Vol
5.9460  9.0125  18.3448  90.000  90.000  90.000  983.07
0.0003  0.0004  0.0009  0.001  0.001  0.001  0.13
Corrected for goodness of fit:
0.0003  0.0005  0.0010  0.001  0.001  0.001  0.16

Range of reflections used:
Worst res Best res Min 2Theta Max 2Theta
9.1724  0.7496  4.441  56.600

Crystal system constraint:          5(Orthorhombic)
Parameter constraint mask:         512
Eulerian angles:                   68.999   49.891  -104.504
Sonometer zeros (deg):             0.0000  0.1185  0.0000  -0.0013
Crystal translations (pixels):     0.0000  0.0000  0.0000  0.0000

Detector corrections: X-Cen Y-Cen Dist Pitch Roll Yaw
                       0.721  -0.097  -0.013  0.332  -0.305  -0.210
Refinement statistics: StartingRes FinalRes GOF #Cycles Code
                       2.04334E+05  2.34486E+04  1.46      3      0

New orientation is in D:\frames\ylidi\work\YLID1m.p4p
End Final global unit cell least squares refinement ===== 08/08/00 13:48:31
Press ENTER to continue...

```

Figure 5-9. Integration summary

- Before pressing the Enter key, scroll up the screen to display the summary table from the integration process (Figure 5-10).

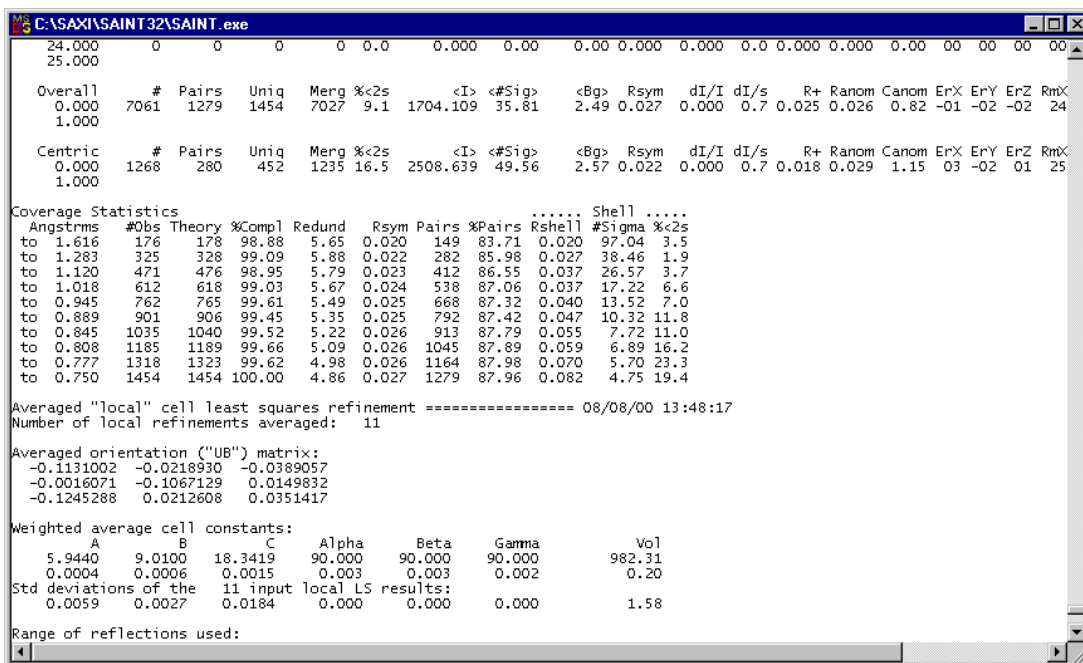

Figure 5-10. Viewing log files

Your results should be similar to those displayed above.

- Press Enter, and close all SAINT windows and exit from the SAINTPLUS menu.

You are now ready to begin the structure determination and refinement process.

6 Structure Determination & Refinement

You are now ready to solve and refine the crystal structure for the YLID test crystal. The integration process (SAINT) has produced two important files—YLID1M.p4p, containing the final unit cell parameters and other important information on how the experiment was carried out, and YLID1M.raw, containing the actual intensity data. These files are all that is

required to begin the structure solution and refinement process. The various steps in solving and refining the structure are carried out using the programs of the SHELXTL package.

A simplified flow chart is shown in Figure 6-1.

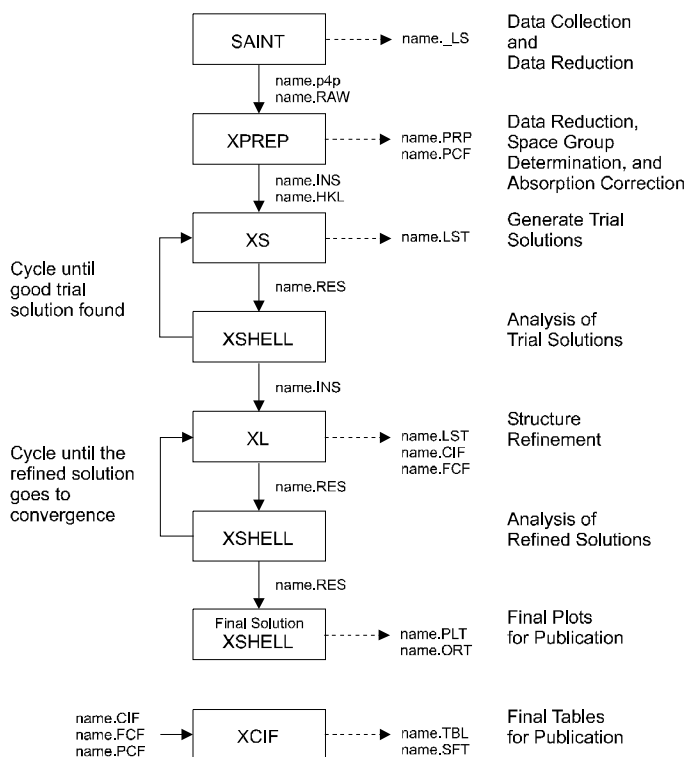

Figure 6-1. Flow chart

Solve and refine the crystal structure as follows:

1. Click the SHELXTL icon in the Bruker AXS folder to start SHELXTL (recall Figure 4-2).
2. Click Project > New to create a new project for the YLID (Figure 6-2).

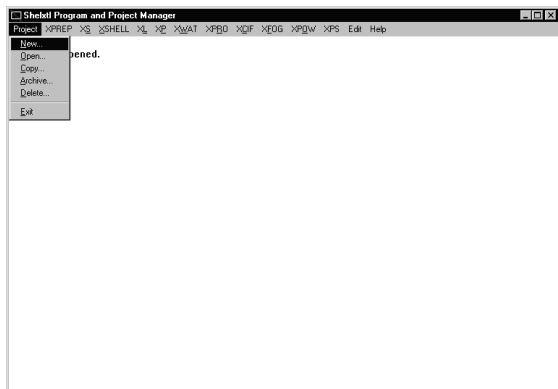

Figure 6-2. Create a new project

3. Use the built-in Explorer to locate the YLID1m.raw file. In this example, the file is in D:\frames\ylid1\work (Figure 6-3).

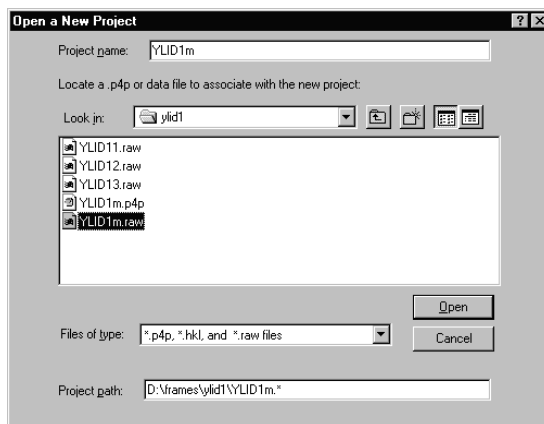

Figure 6-3. Locate the YLID1m.p4p file

The SHELXTL Program and Project Manager window appears (Figure 6-4).



Figure 6-4. SHELXTL Program and Project Manager window

- Click XPREP > XPREP (or XPREP > BigXPREP). The first XPREP window appears (Figure 6-5).

```
BIGXPREP - [V5.1 Copyright (c) 1997 Bruker AXS]

+++++
+  XPREP - DATA PREPARATION & RECIPROCAL SPACE EXPLORATION  Ver. 5.1/NT  +
+  COPYRIGHT(c) 1997 Bruker Analytical X-ray Systems  All Rights Reserved  +
+++++

** Data multiplied by 0.1000  to bring onto reasonable scale **

      6498 Reflections read from file ylid1m.raw
      Mean (I/sigma) = 19.52

Lattice exceptions: P      A      B      C      I      F      Obv      Rev      All
N (total) =          0  3233  3249  3254  3260  4868  4329  4326  6498
N (int>3sigma) =     0  2840  2794  2902  2852  4268  3768  3767  5669
Mean intensity =  0.0 168.1 161.2 154.4 171.9 161.2 165.6 166.2 164.9
Mean int/sigma =  0.0 20.0  18.9  19.2  19.8  19.4  19.6  19.5  19.5

Lattice type [P, A, B, C, I, F, O(obv.), R(rev. rhomb. on hex. axes)]
Select option [P]:
```

Figure 6-5. First XPREP window

5. The lattice is Primitive [P]. Press RETURN. The second XPREP window appears (Figure 6-6).

```
BIGXPREP - [V5.1 Copyright (c) 1997 Bruker AXS]
Current dataset: ylidm.raw          Wavelength: 0.71073 Chiral: ?
-----
Original cell:  5.960  9.034 18.384  90.00  90.00  90.00  Vol  989.8
                Esds:  0.000  0.001  0.001  0.00  0.00  0.00  Lattice: P
-----
Current cell:   5.960  9.034 18.384  90.00  90.00  90.00  Vol  989.8
-----
Matrix: 1.0000  0.0000  0.0000  0.0000  1.0000  0.0000  0.0000  0.0000  1.0000
-----

[D] Read, modify or merge DATASETS      [C] Define unit-cell CONTENTS
[P] Contour PATTERSON sections          [F] Set up shelxtl FILES
[H] Search for HIGHER metric symmetry   [R] RECIPROCAL space displays
[S] Determine or input SPACE GROUP      [U] UNIT-CELL transformations
[A] Apply ABSORPTION corrections        [T] Change TOLERANCES
[L] Reset LATTICE type of original cell [Q] QUIT program

Select option [H]:
```

Figure 6-6. Second XPREP window

6. Press RETURN to execute the search for higher metric symmetry [H]. The program has determined that the YLID crystal has an orthorhombic primitive lattice (Figure 6-7).

```

BIGXPREP - [V5.1 Copyright (c) 1997 Bruker AXS]
Current dataset: ylidim.raw          Wavelength: 0.71073 Chiral: ?
-----
Original cell:  5.960  9.034 18.384  90.00  90.00  90.00  Vol  989.8
Esds:          0.000  0.001  0.001  0.00  0.00  0.00  Lattice: P
-----
Current cell:   5.960  9.034 18.384  90.00  90.00  90.00  Vol  989.8
-----
Matrix: 1.0000  0.0000  0.0000  0.0000  1.0000  0.0000  0.0000  0.0000  1.0000
-----

[D] Read, modify or merge DATASETS          [C] Define unit-cell CONTENTS
[P] Contour PATTERSON sections              [F] Set up shelxtl FILES
[H] Search for HIGHER metric symmetry       [R] RECIPROCAL space displays
[S] Determine or input SPACE GROUP          [U] UNIT-CELL transformations
[A] Apply ABSORPTION corrections           [T] Change TOLERANCES
[L] Reset LATTICE type of original cell    [Q] QUIT program

Select option [H]:

Determination of reduced (Niggli) cell

Transformation from original cell (HKLf-matrix):
  1.0000  0.0000  0.0000  0.0000  1.0000  0.0000  0.0000  0.0000  1.0000

Unitcell:      5.960  9.034 18.384  90.00  90.00  90.00

Niggli form:   a.a =   35.52    b.b =   81.61    c.c =   337.97
               b.c =    0.00    a.c =    0.00    a.b =    0.00

Search for higher METRIC symmetry

-----
Option A: FOM = 0.000 deg.  ORTHORHOMBIC P-lattice  R(int) = 0.032 [ 5070]
Cell:      5.960  9.034 18.384  90.00  90.00  90.00  Volume:  989.82
Matrix: 1.0000  0.0000  0.0000  0.0000  1.0000  0.0000  0.0000  0.0000  1.0000
-----
Option B retains original cell

Select option [A]:

```

Figure 6-7. YLID crystal, orthorhombic primitive lattice

7. Press RETURN to select cell choice A.
The next XPREP window appears (Figure 6-8).

```
BIGXPREP - [V5.1 Copyright (c) 1997 Bruker AXS]
Current dataset: ylidm.raw          Wavelength: 0.71073 Chiral: ?
-----
Original cell:  5.960  9.034  18.384  90.00  90.00  90.00  Vol  989.8
Esds:  0.000  0.001  0.001  0.00  0.00  0.00  Lattice: P
-----
Current cell:  5.960  9.034  18.384  90.00  90.00  90.00  Vol  989.8
-----
Matrix: 1.0000  0.0000  0.0000  0.0000  1.0000  0.0000  0.0000  0.0000  1.0000
-----
Crystal system: Orthorhombic      Lattice: P
-----
[D] Read, modify or merge DATASETS      [C] Define unit-cell CONTENTS
[P] Contour PATTERSON sections          [F] Set up shelxtl FILES
[H] Search for HIGHER metric symmetry   [R] RECIPROCAL space displays
[S] Determine or input SPACE GROUP      [U] UNIT-CELL transformations
[A] Apply ABSORPTION corrections        [T] Change TOLERANCES
[L] Reset LATTICE type of original cell [Q] QUIT program

Select option [S]:
```

Figure 6-8. Next XPREP window

8. Press RETURN to choose the SPACE GROUP option [S]. SMART will then prompt you for four selections: determine space group [S], the crystal system [O], the lattice centering [P], and the space group [A] = $P2_12_12_1$. All prompts and data are shown in Figure 6-9.

```

BIGXPREP - [V5.1 Copyright (c) 1997 Bruker AXS]
[S] Determine SPACE GROUP
[C] Must be CHIRAL (sample is optically active)
[N] NOT NECESSARILY chiral (eg. may be racemate)
[I] INPUT known space group
[E] EXIT to main menu or [Q] QUIT program

Select option [S]:

[A] Triclinic, [M] Monoclinic, [O] Orthorhombic, [T] Tetragonal,
[H] Trigonal/Hexagonal, [C] Cubic or [E] EXIT

Select option [O]:

Lattice exceptions: P      A      B      C      I      F      Obv      Rev      All
N (total) =           0      3233      3249      3254      3260      4868      4329      4326      6498
N (int>3sigma) =      0      2840      2794      2902      2852      4268      3768      3767      5669
Mean intensity =    0.0      168.1      161.2      154.4      171.9      161.2      165.6      166.2      164.9
Mean int/sigma =    0.0      20.0      18.9      19.2      19.8      19.4      19.6      19.5      19.5

Lattice type [P, A, B, C, I, F, O(obv.), R(rev. rhomb. on hex. axes)]

Select option [P]:

Mean |E*E-1| = 0.686 [expected .968 centrosym and .736 non-centrosym]

Systematic absence exceptions:

      b--  c--  n--  21--  -c-  -a-  -n-  -21-  --a  --b  --n  --21
N      334  330  326   7  212  222  212   11  127  121  122   15
N I>3s  283  274  265   0  158  162  134   0  100  100   94    1
<I>    189.8  208.9  260.3  0.5  277.7  275.8  145.6  0.5  214.1  244.4  195.3  0.6
<I/s>  23.3  24.4  26.3  1.0  26.2  25.4  15.0  0.6  22.5  25.5  21.7  1.0

Option Space Group No. Type Axes CSD R(int) N(eq) Syst. Abs. CFOM
[A] P2(1)2(1)2(1) # 19 chiral 1 5917 0.032 5070 1.0 / 15.0 0.96

Select option [A]:

```

Figure 6-9. Next XPREP window

9. Press RETURN to choose option [A]. The next XPREP window appears (Figure 6-10).

```

XPREP ver 6.07/Win Copyright Bruker-AXS 2000
Current dataset: ylidim.hkl Wavelength: 0.71073 Chiral: ?
-----
Original cell: 5.951 9.021 18.361 90.00 90.00 90.00 Vol 985.7
Esds: 0.000 0.001 0.001 0.00 0.00 0.00 Lattice: P
-----
Current cell: 5.951 9.021 18.361 90.00 90.00 90.00 Vol 985.7
-----
Matrix: 1.0000 0.0000 0.0000 0.0000 1.0000 0.0000 0.0000 0.0000 1.0000
-----
Crystal system: Orthorhombic Space group: P2 (1)2 (1)2 (1) # 19 [chi] Laue: 3
-----

[D] Read, modify or merge DATASETS [C] Define unit-cell CONTENTS
[P] Contour PATTERN sections [F] Set up shelxtl FILES
[H] Search for HIGHER metric symmetry [R] RECIPROCAL space displays
[S] Determine or input SPACE GROUP [U] UNIT-CELL transformations
[A] Apply ABSORPTION corrections [T] Change TOLERANCES
[L] Reset LATTICE type of original cell [Q] QUIT program

Select option [D]:

```

Figure 6-10. Next XPREP window

10. Press RETURN to choose the read, modify, or merge datasets option [D]. The next XPREP window appears (Figure 6-11).

```

XPREP ver 6.07/Win Copyright Bruker-AXS 2000
Index # Data Filename or Source of Data
-----
1 6860 ylidim.hkl <- current dataset

[M] Sort-MERGE current data (no scaling) [C] Change CURRENT dataset
[L] LINEAR scale and merge datasets [W] WRITE dataset to file
[I] ISOTROPIC scale and merge datasets [R] READ in another dataset
[S] Display intensity STATISTICS [D] DELETE stored dataset
[F] FACE-indexed absorption corrections [P] PSI-scan absorption corr.
[T] Copy file, TRANSFORM hkl and cosines [A] MAD, SAS, SIR or SIRAS
[H] Apply HIGH/low resolution cutoffs [N] NORMALIZE/scale sigmas
[E] EXIT to main menu [Q] QUIT program

Select option [S]:

```

Figure 6-11. Next XPREP window

11. Press RETURN to choose the display intensity statistics option [S]. The next XPREP window appears (Figure 6-12).

```

XPREP ver 6.07/Win Copyright Bruker-AXS 2000
Current dataset: ylidm.hkl

[N] Do NOT merge reflections
[I] Merge IDENTICAL indices only
[S] Merge SYMMETRY equivalents (but not Friedel opposites)
[A] Merge ALL equivalents (including Friedel opposites)
[E] EXIT to merge datasets menu
[Q] QUIT program

Select option [A]:

```

Figure 6-12. Next XPREP window

12. Press RETURN to choose the merge all equivalents including Friedel mates option [A]. The next XPREP window appears (Figure 6-13).

Compare data in the circled areas and note that the data set is virtually complete to 0.75 Å with an average redundancy of >4. The overall R_{merge} is 2.72%.

```

XPREP ver 6.07/Win Copyright Bruker-AXS 2000

Resolution  #Data #Theory %Complete Redundancy Mean I Mean I/s Rint Rsigma
Inf - 2.20   76   77   98.7    4.75  1104.3  138.74  0.0206  0.0054
2.20 - 1.70   79   79  100.0    5.82   437.2   95.96  0.0206  0.0078
1.70 - 1.45   80   81   98.8    5.81   318.5   83.63  0.0247  0.0101
1.45 - 1.30   80   81   98.8    6.15   181.3   59.77  0.0296  0.0140
1.30 - 1.15  125  126   99.2    5.46   155.8   48.25  0.0368  0.0170
1.15 - 1.05  133  133  100.0    5.03   85.8    31.20  0.0348  0.0256
1.05 - 0.95  176  176  100.0    4.85    63.9    24.58  0.0390  0.0343
0.95 - 0.90  125  125  100.0    4.42    43.2    17.91  0.0450  0.0476
0.90 - 0.85  147  147  100.0    4.19    28.6    12.94  0.0537  0.0644
0.85 - 0.80  197  197  100.0    4.11    24.6    11.41  0.0606  0.0749
0.80 - 0.75  238  238  100.0    3.68    17.5     8.15  0.0763  0.1059
0.75 - 0.75    1    1  100.0    3.00    27.6    11.15  0.0196  0.0897
-----
0.85 - 0.75  436  436  100.0    3.87    20.7     9.63  0.0673  0.0892
Inf - 0.75  1457 1461  99.7    4.70    150.5   35.99  0.0272  0.0161

Merged [A], lowest resolution = 18.36 Angstroms, 357 outliers downweighted
Enter <CR> to continue

```

Figure 6-13. Next XPREP window

13. Press RETURN to continue displaying the window. The next XPREP window appears (Figure 6-14).

```
XPREP ver 6.07/Win      Copyright Bruker-AXS 2000
Index  # Data  Filename or Source of Data
  1    6860  ylidim.hkl  <- current dataset

[M] Sort-MERGE current data (no scaling)  [C] Change CURRENT dataset
[L] LINEAR scale and merge datasets       [W] WRITE dataset to file
[I] ISOTROPIC scale and merge datasets    [R] READ in another dataset
[S] Display intensity STATISTICS         [D] DELETE stored dataset
[F] FACE-indexed absorption corrections   [P] PSI-scan absorption corr.
[T] Copy file, TRANSFORM hkl and cosines [A] M&D, SAS, SIR or SIRAS
[H] Apply HIGH/low resolution cutoffs    [N] NORMALIZE/scale sigmas
[E] EXIT to main menu                   [Q] QUIT program

Select option [E]:
```

Figure 6-14. Next XPREP window

14. Press option [E] to return to the main window. The following window appears (Figure 6-15).

```

XPREP ver 6.07/Win      Copyright Bruker-AXS 2000
-----
Current dataset: ylidm.hkl      Wavelength: 0.71073 Chiral: ?
-----
Original cell:  5.951  9.021  18.361  90.00  90.00  90.00  Vol  985.7
                Esds:  0.000  0.001  0.001  0.00  0.00  0.00      Lattice: P
-----
Current cell:   5.951  9.021  18.361  90.00  90.00  90.00  Vol  985.7
-----
Matrix:  1.0000  0.0000  0.0000  0.0000  1.0000  0.0000  0.0000  0.0000  1.0000
-----
Crystal system: Orthorhombic  Space group: P2(1)2(1)2(1) # 19 [chi]  Laue: 3
-----

[D] Read, modify or merge DATASETS          [C] Define unit-cell CONTENTS
[P] Contour PATTERSON sections              [F] Set up shelxtl FILES
[H] Search for HIGHER metric symmetry       [R] RECIPROCAL space displays
[S] Determine or input SPACE GROUP          [U] UNIT-CELL transformations
[A] Apply ABSORPTION corrections            [T] Change TOLERANCES
[L] Reset LATTICE type of original cell     [Q] QUIT program

Select option [C]: █

```

Figure 6-15. Next XPREP window

15. Press RETURN to choose the Define Unit Cell option [C]. The unit cell contents will be summarized on the next menu (Figure 6-16).

```
BIEXPREP - [V5.1 Copyright (c) 1997 Bruker AXS]
Current formula is: C11_H10_O2_S
Tentative Z (number of formula units/cell) = 4.0 giving rho = 1.384,
non-H atomic volume = 17.7 and following cell contents and analysis:
C      44.00   64.05 %      H      40.00   4.89 %
O       8.00   15.52 %      S       4.00   15.54 %

[Z] change Z, [F] new FORMULA, [R] change RADIATION,
[E] EXIT to main menu or [Q] QUIT program

Select option [E]:
```

Figure 6-16. Summarized unit cell contents

16. If you did not enter the chemical formula when you created the new project for the YLID crystal in the SMART program, you must do so now. The correct chemical formula for the YLID crystal is C₁₁ H₁₀ O₂ S. If the information is correct, press RETURN to display the next window (Figure 6-17).
17. Press RETURN to keep the current name, then type Y to write the YLID1m.HKL file.
18. You may now press RETURN, for option [E], to return to the main SHELXTL menu.

```

* BIGXPREP - [V5.1 Copyright (c) 1997 Bruker AXS]
Current dataset: ylidm.raw          Wavelength: 0.71073 Chiral: ?
-----
Original cell:  5.960  9.034 18.384  90.00  90.00  90.00  Vol  989.8
Esds:          0.000  0.001  0.001  0.00  0.00  0.00  Lattice: P
-----
Current cell:  5.960  9.034 18.384  90.00  90.00  90.00  Vol  989.8
-----
Matrix: 1.0000  0.0000  0.0000  0.0000  1.0000  0.0000  0.0000  0.0000  1.0000
-----
Crystal system: Orthorhombic Space group: P2(1)2(1)2(1) # 19 [chi] Laue: 3
-----
Formula: C11 H10 O2 S              Formula wt: 206.25
Z: 4.00 Density: 1.384 At.vol: 17.7 F(000): 432.00 Mu[mm-1]: 0.29
-----

[D] Read, modify or merge DATASETS      [C] Define unit-cell CONTENTS
[P] Contour PATTERSON sections          [F] Set up shelxtl FILES
[H] Search for HIGHER metric symmetry   [R] RECIPROCAL space displays
[S] Determine or input SPACE GROUP      [U] UNIT-CELL transformations
[A] Apply ABSORPTION corrections        [T] Change TOLERANCES
[L] Reset LATTICE type of original cell [Q] QUIT program

Select option [F]:

Output file name (without extension) [YLID1m]:

File ylidm.ins set up as follows:

TITL YLID1m in P2(1)2(1)2(1)
CELL 0.71073  5.9601  9.0336 18.3840  90.000  90.000  90.000
ZERR 4.00  0.0003  0.0005  0.0010  0.000  0.000  0.000
LATT -1
SYMM 0.5-X, -Y, 0.5+Z
SYMM -X, 0.5+Y, 0.5-Z
SYMM 0.5+X, 0.5-Y, -Z
SFAC C H O S
UNIT 44 40 8 4
TEMP 23
TREF
HKL 4
END

Do you wish to (over)write the intensity data file ylidm.hkl ? [N]: y

```

Figure 6-17. Next window

The XPREP program has created an YLID1m.ins file and an YLID1m.hkl file (recall Figure 6-1). You are now ready to solve the structure of the YLID sample.

- Click on the XS command at the top of the menu to launch the XS (structure solution) program (Figure 6-18).

```

C:\WINNT\System32\CMD.exe
104 Reflections and 1066. unique TPR for phase annealing
149 Phases refined using 2642. unique TPR
169 Reflections and 3344. unique TPR for R(alpha)
594 Unique negative quartets found, 594 used for phase refinement
141 Unique NQR employed in phase annealing
128 Parallel refinements, highest memory = 4261 / 44577

Try Ralpha Nqual Sigma-1 M(abs) CFOM Seminvariants
181393. 0.053 -0.775 0.967 1.122 0.053* +-+--++-+ +-+--+
Freq: 0 0 111 6 3 1 0 0 0 0 0 0 0 0 0 0 1 0 0 0 0 0 1 0 0 0 0 / 128
464681. 0.053 -0.810 0.967 1.131 0.053 +-+--++-+ +-+--+
Freq: 0 0 207 19 9 4 0 0 0 0 0 0 0 0 1 0 0 1 1 1 0 0 0 0 0 1 0 0 0 0 / 256

256. Phase sets refined - best is code 181393. with CFOM = 0.0529

Fourier and peaksearch
RE = 0.130 for 14 atoms and 452 E-values
Fourier and peaksearch
RE = 0.118 for 14 atoms and 452 E-values
Fourier and peaksearch

*****
+ ylidm finished at 07:57:27 Total elapsed time: 4.1 secs +
*****
Press any key to continue . . .

```

Figure 6-18. Launch the XS program

- When the program has finished running, press RETURN. The SHELXTL summary window redisplay (recall Figure 6-3).

21. Click on the XSHELL button to start the XSHELL program. The Fourier peaks will be displayed (Figure 6-19).

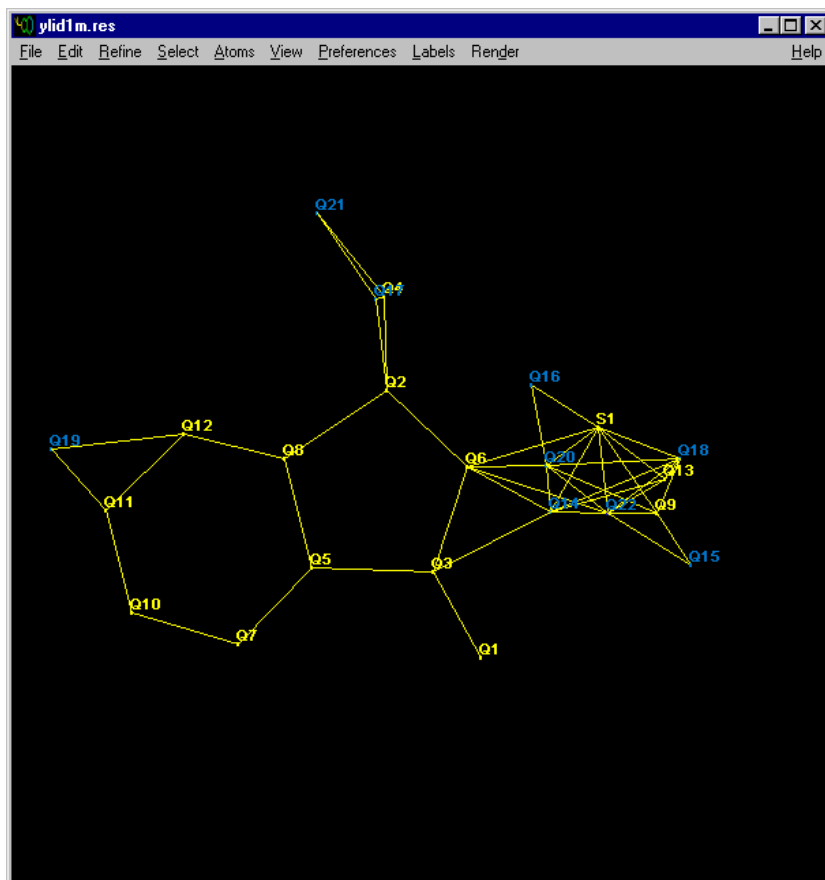

Figure 6-19. Fourier peaks

22. You may rotate the structure by dragging the mouse with the left button depressed. Select all false peaks (peaks Q14 to Q22 in the example shown) by moving the mouse to each peak and clicking the right mouse button.

Note: For more detailed instructions on use of the XSHHELL program, see the XSHHELL User's Manual.

Note: You can also use the S key to select a peak directly.

The peak should turn blue when selected. The molecule may be rotated during this process (Figure 6-20).

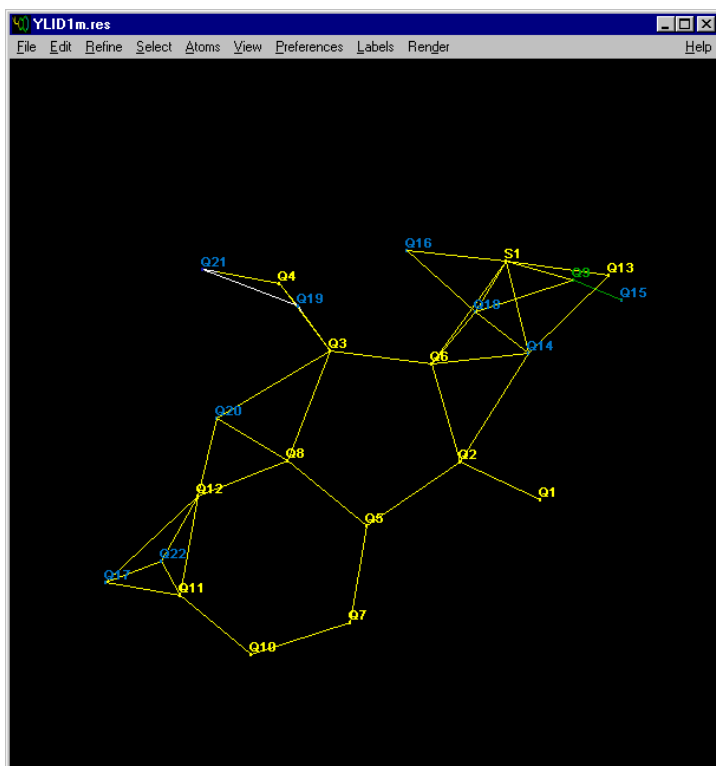

Figure 6-20. Molecule with peaks Q14 to Q22 selected

23. When all false peaks have been selected, click the Kill Selected button in the Select menu. The peaks will disappear (Figure 6-21).

24. Select the 11 peaks that correspond to carbon atoms (9 atoms in fused 5- & 6-membered ring, 2 atoms attached to S atom) in the order in which they are to be numbered.

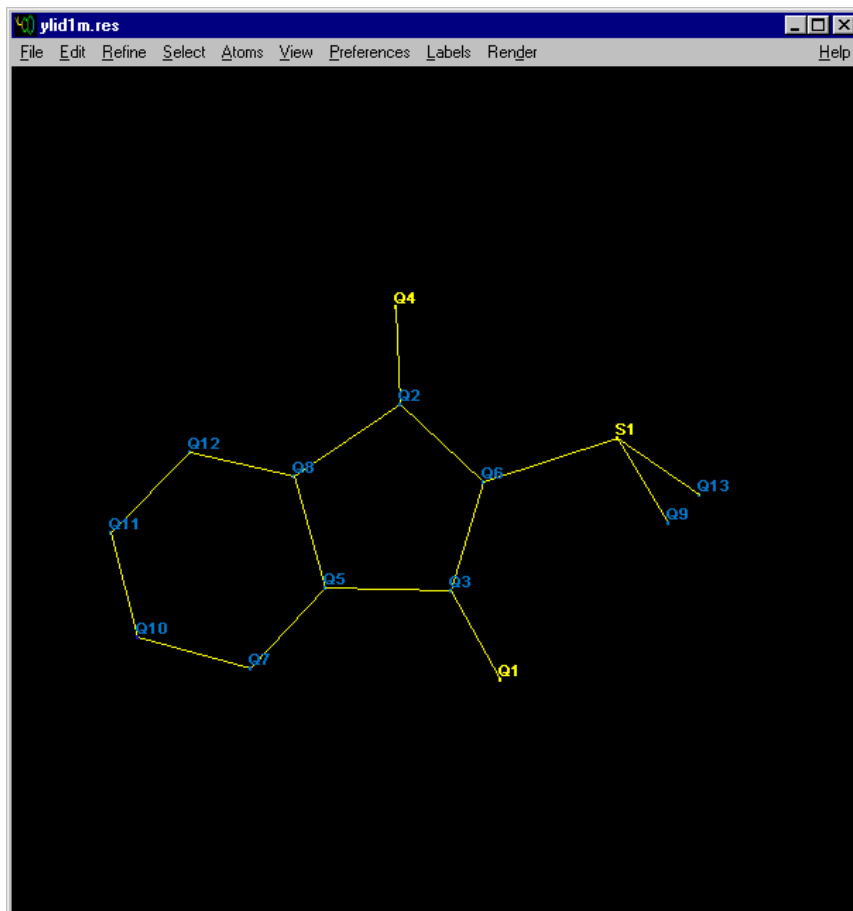

Figure 6-21. Peaks disappear

25. Click Labels > Group Label (Figure 6-22).

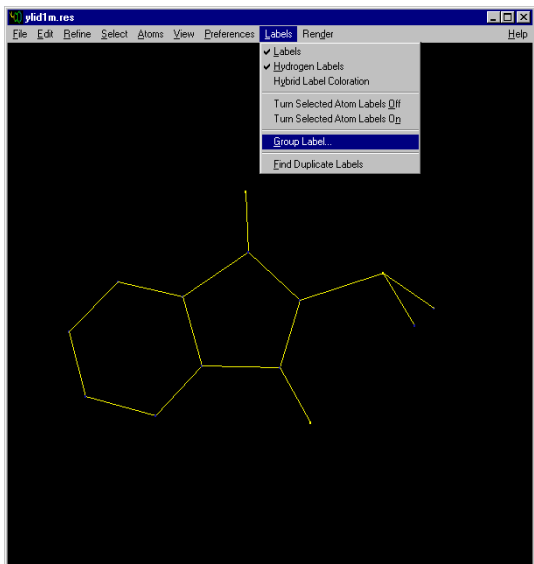

Figure 6-22. Select Group Labels

A panel will appear to label these peaks (Figure 6-23).

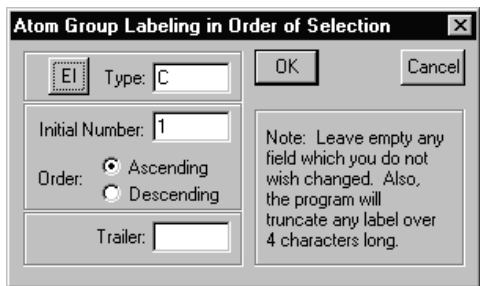

Figure 6-23. Input panel

26. Click OK to label these peaks as C with a starting number of 1 (Figure 6-24).

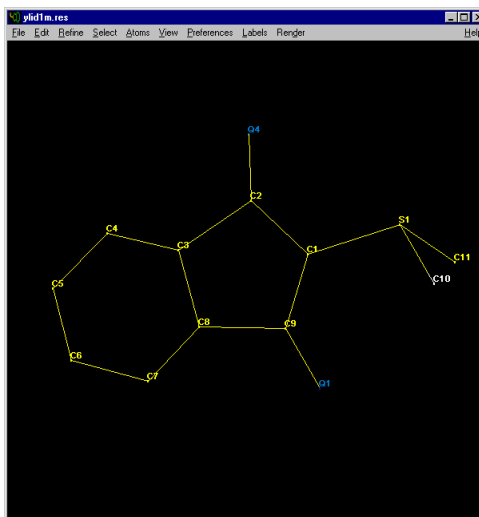

Figure 6-24. Label the peaks

27. Select the two remaining atoms. Then click Labels > Group Label again, and click the EI button. A periodic table will appear (Figure 6-25).

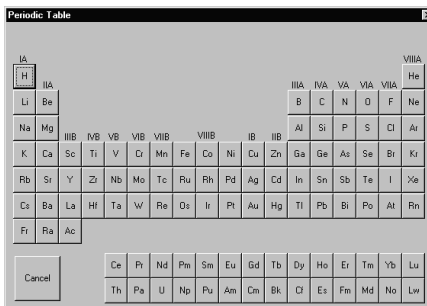

Figure 6-25. Periodic table

28. Click the O button for Oxygen. A panel appears for you to label these peaks (Figure 6-26).

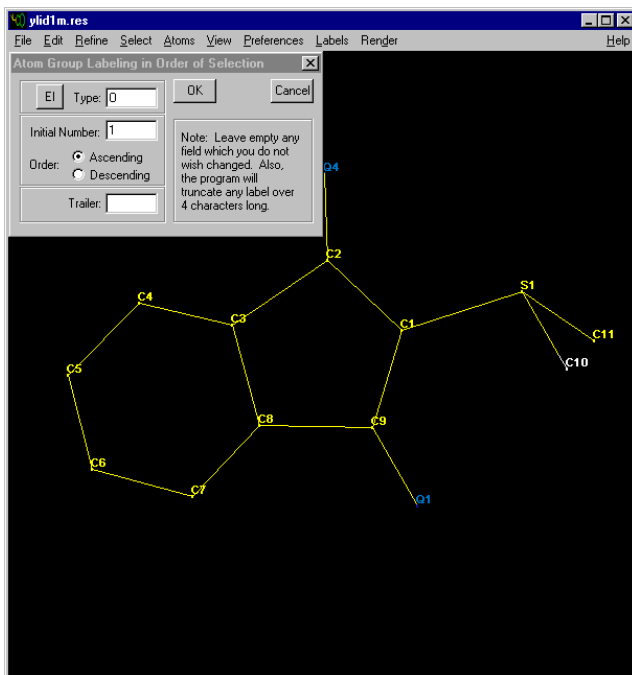

Figure 6-26. Input panel appears

29. Click OK to label the peaks as O with a starting number of 1.
30. Click the Refine button at the top of the XSHELL Menu. A panel will appear (Figure 6-27).

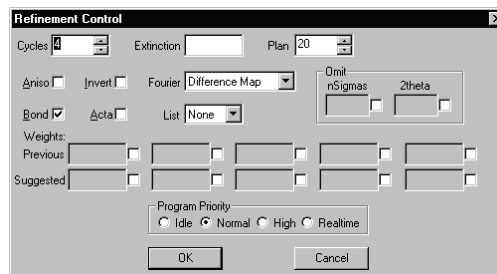

Figure 6-27. Refinement control

31. Click OK to launch the XL (least-squares refinement) program (Figure 6-28).

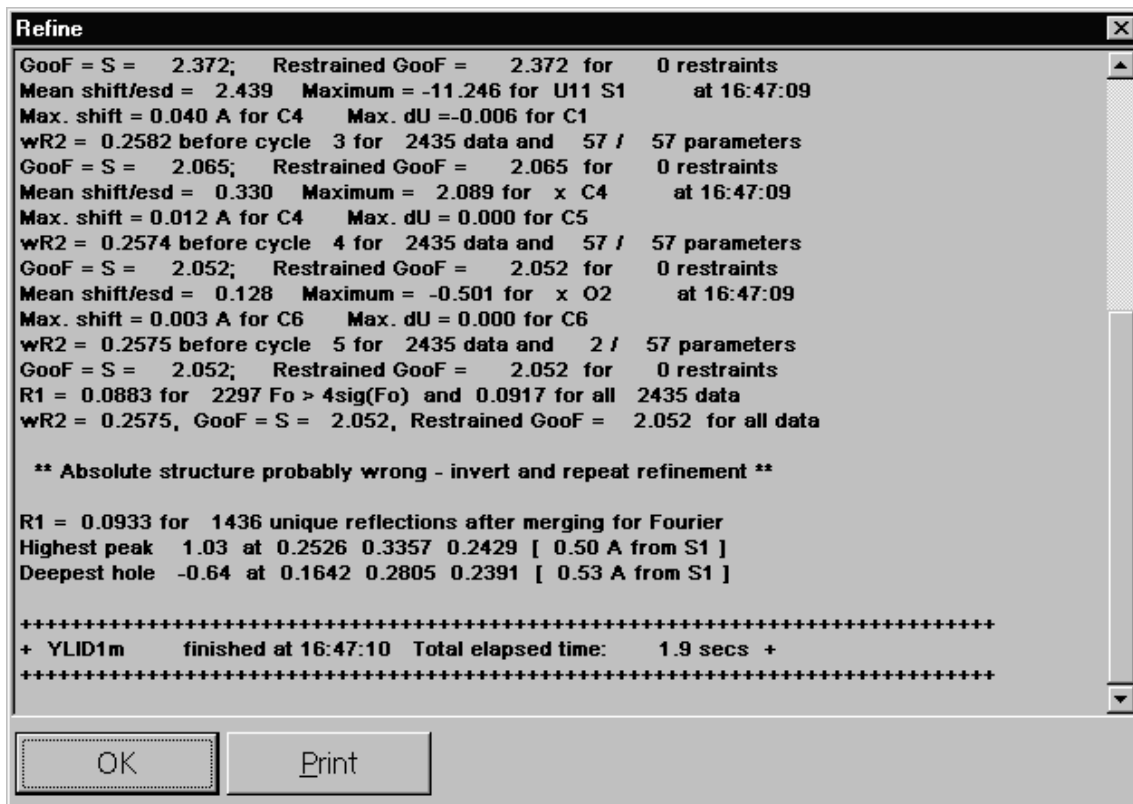

Figure 6-28. Least-squares refinement

In the output above, note that the R1 value is 9.0%. This is typical for a preliminary isotropic refinement with no H atoms included. Also note that, for our sample, the program informs us that we must invert the molecule to obtain the correct absolute structure.

32. Click OK to return to XSHELL.

The Q peaks on the diagram represent difference peaks.

33. You may delete them with the Edit > Kill all Q peaks command (Figure 6-29).

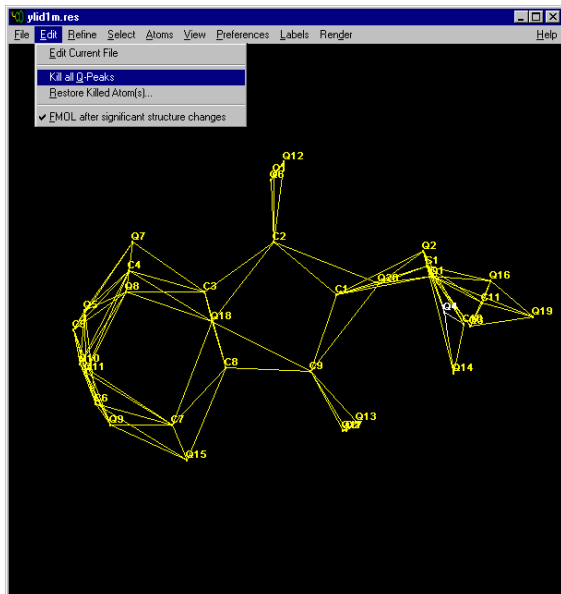

Figure 6-29. Kill all Q-Peaks

34. Click the Refine button at the top of the XSHELL Menu. A panel will appear (Figure 6-30).

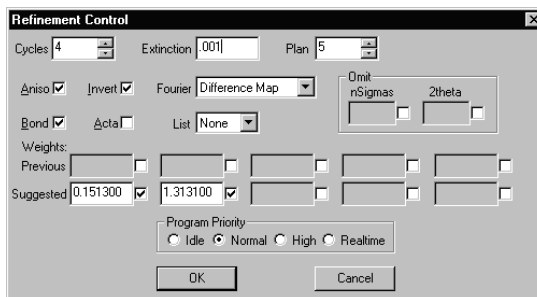

Figure 6-30. Refinement control

35. Change the input values to include Extinction and Anisotropic refinement. Also, reduce the number of difference peaks to 5. If the refinement indicates an inverted structure (as in our example), also check the Invert box.

36. Click OK to launch the XL (least-squares refinement) program (Figure 6-31).

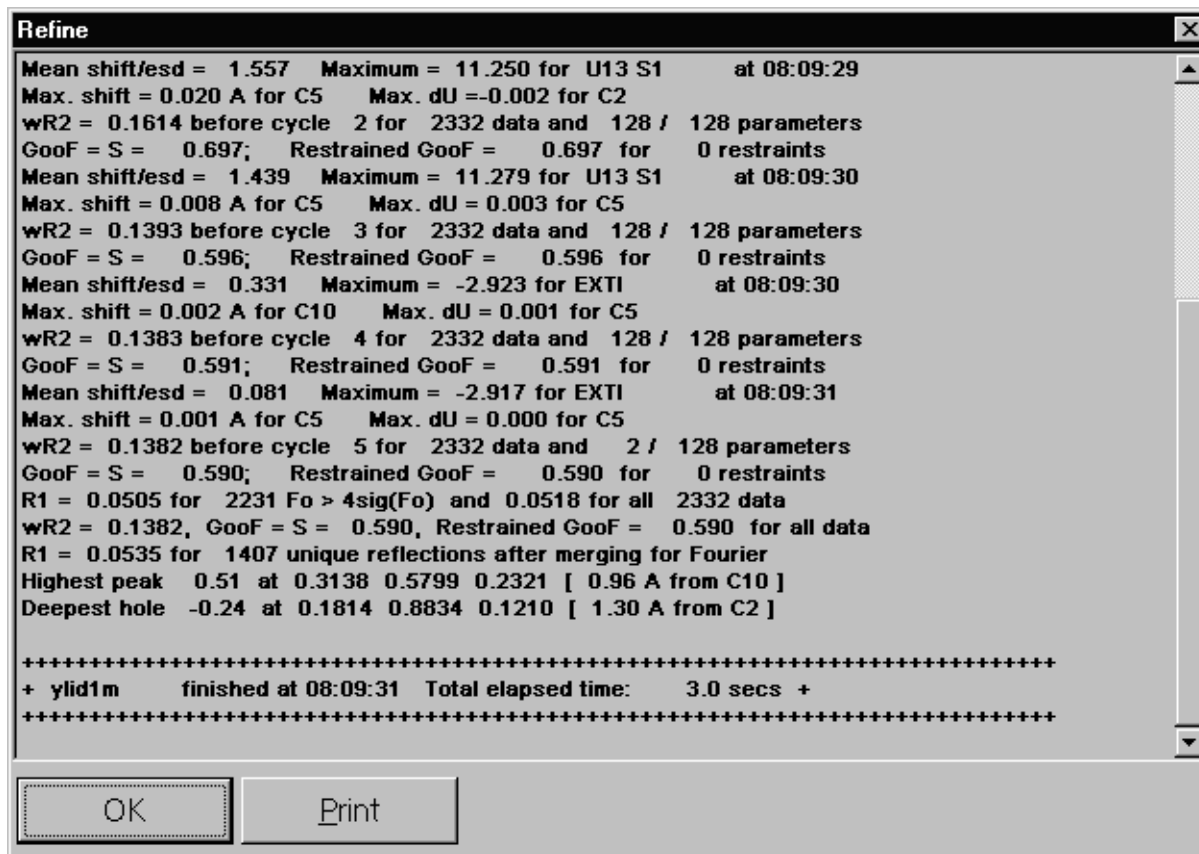

Figure 6-31. Least-squares refinement

In the output above, note that the R1 value is 5.0%. This is typical for a preliminary anisotropic refinement with no H atoms included.

37. Click OK to return to XSHELL.
38. Kill the Q-peaks as before. Then click Atoms > Hybridize All (Figure 6-32). The atoms will appear in different colors.

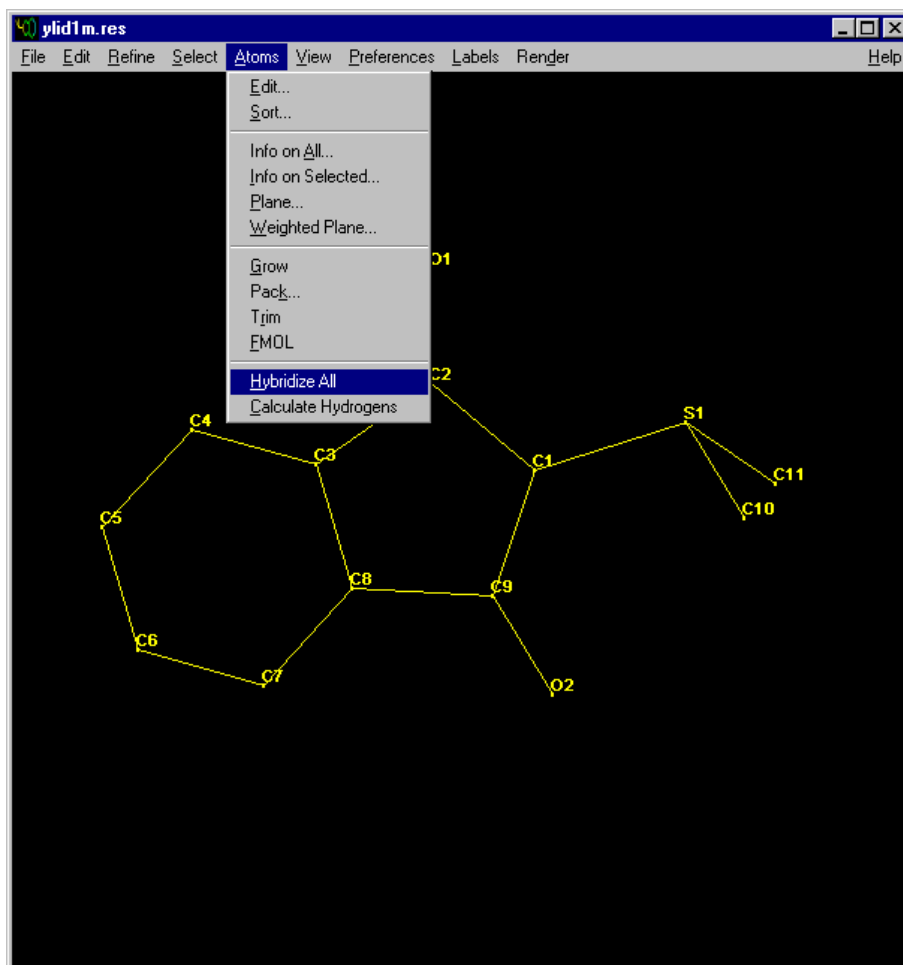

Figure 6-32. Hybridize all

39. Click Atoms > Calculate Hydrogens
(Figure 6-33).

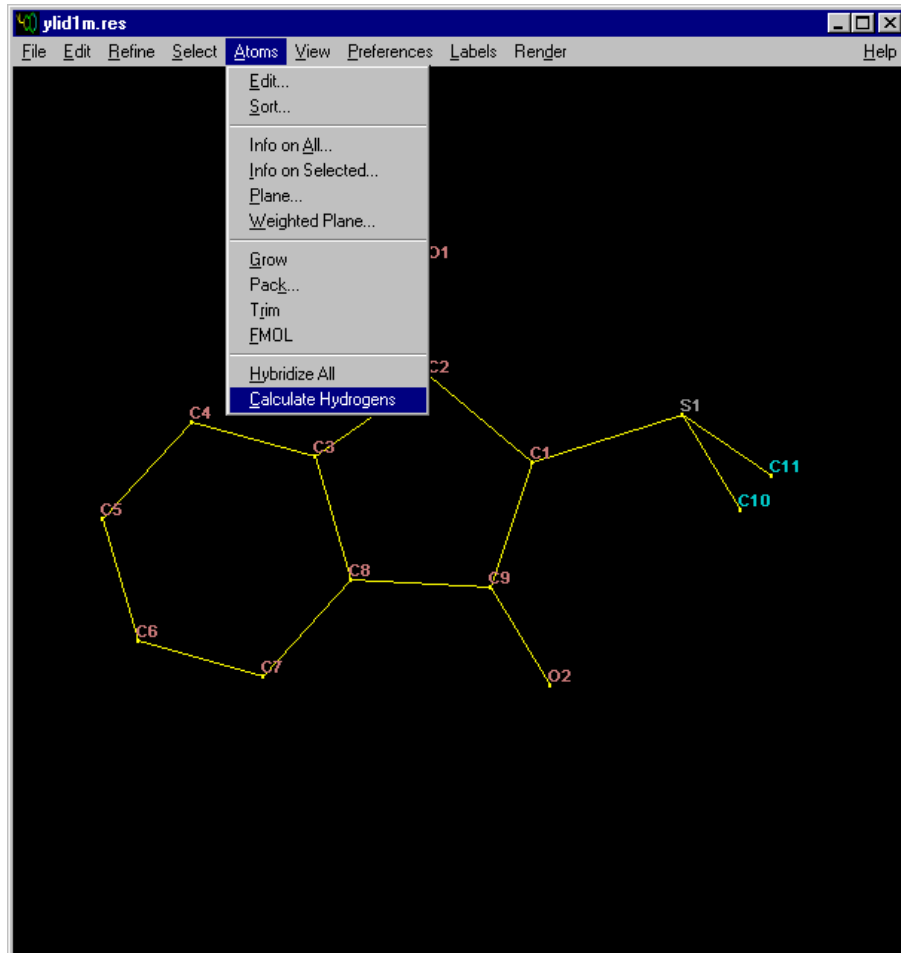

Figure 6-33. Calculate hydrogens

40. The 10 H atoms will be added (Figure 6-34).

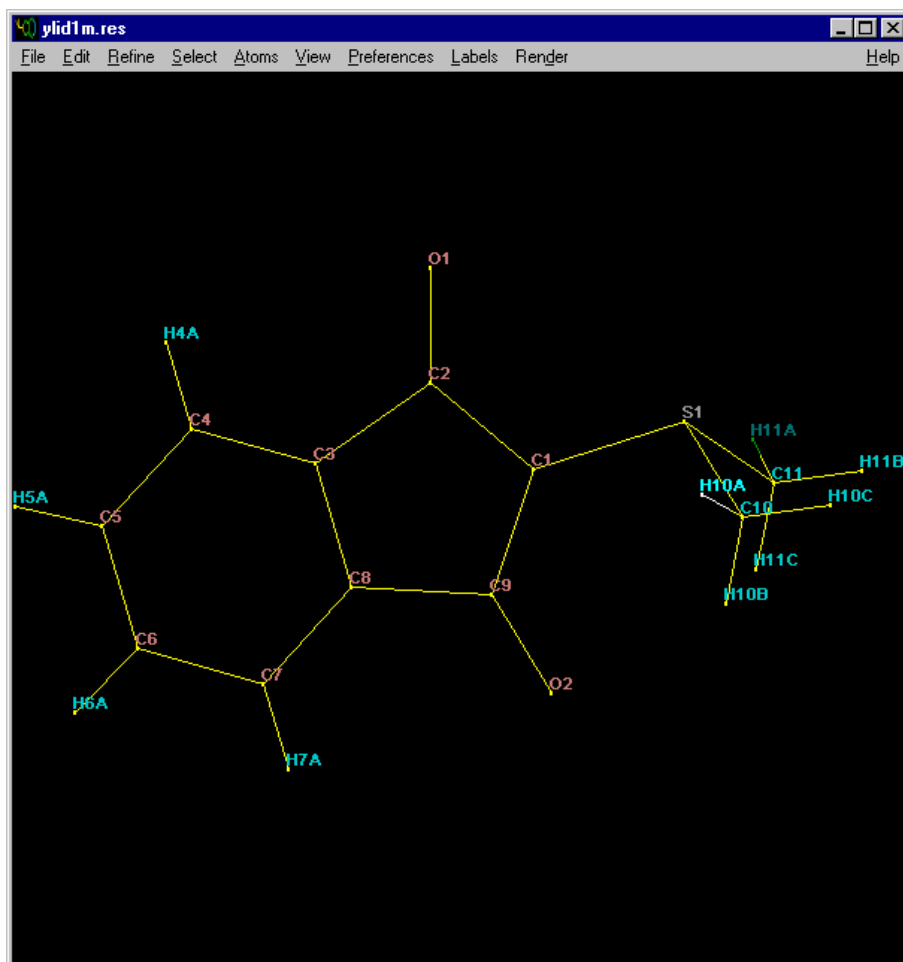

Figure 6-34. Ten H atoms added

41. Click the Refine button at the top of the XSHELL Menu. A panel will appear (Figure 6-35).

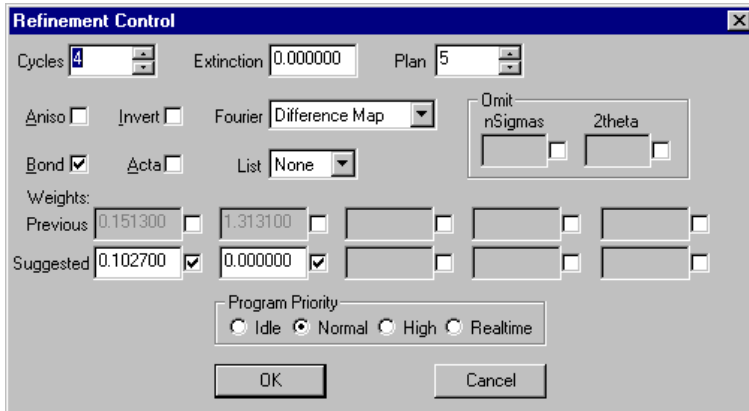

Figure 6-35. Refinement control

42. Click OK to launch the XL (least-squares refinement) program (Figure 6-36).

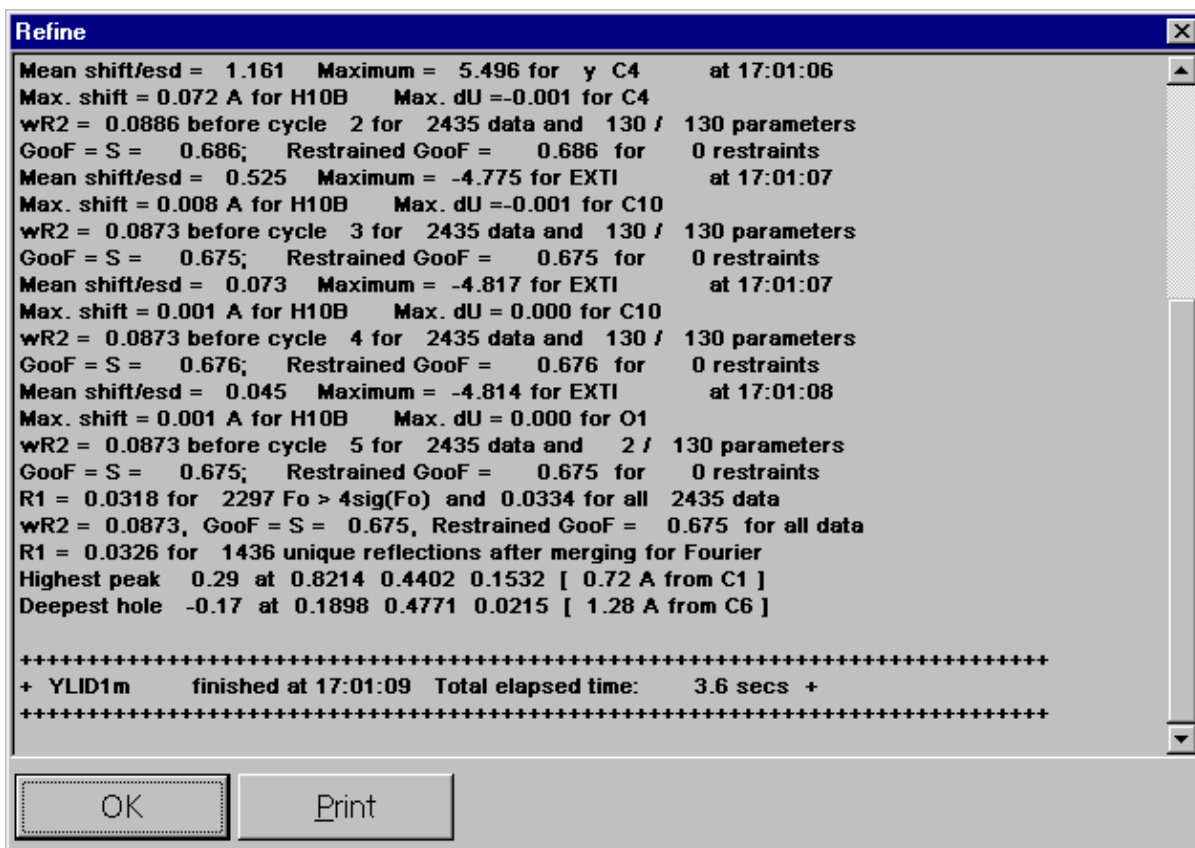

Figure 6-36. Least-squares refinement

In the output above, note that the R1 value is 3.2%. This is typical for an anisotropic refinement with H atoms included.

43. Click OK to return to XSHELL and delete Q peaks.
44. Click the Refine button at the top of the XSHELL Menu. A panel will appear (Figure 6-37).

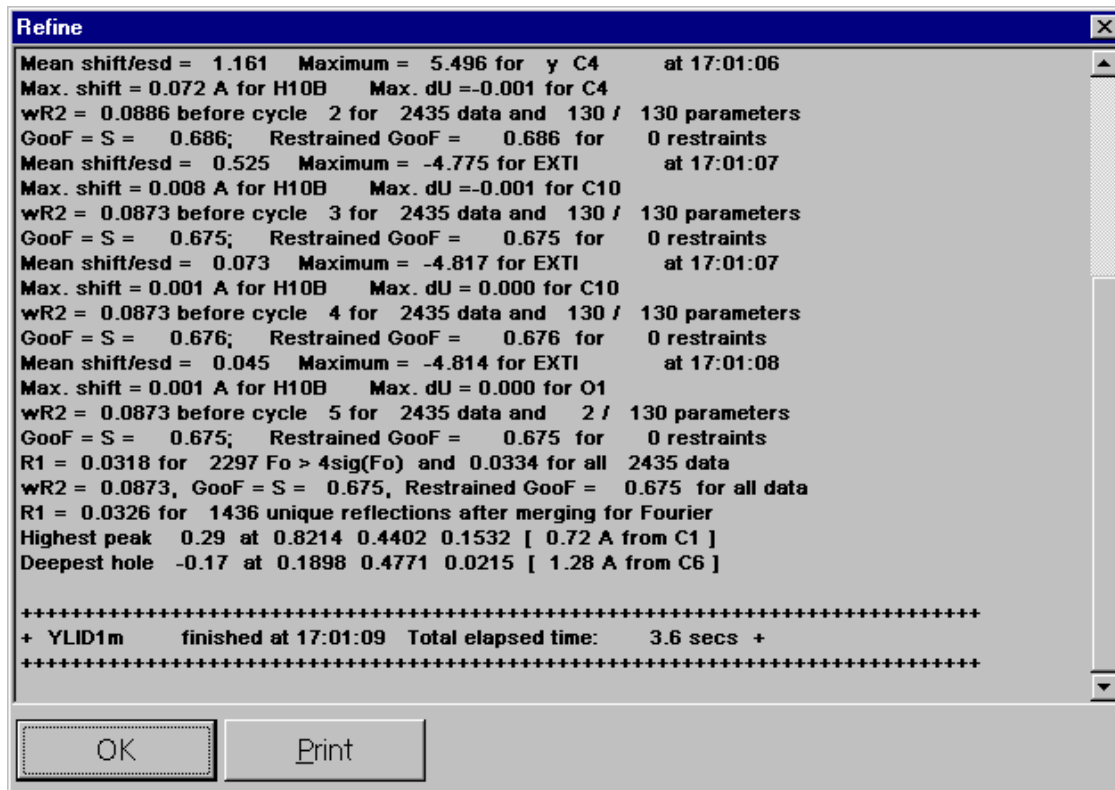

Figure 6-37. Refinement control

Note that the suggested weighting scheme has values of 0.0485 and 0.000. You are now ready for the final least-squares refinement run.

45. Check the Acta box to create .cif files for publication. Click OK to launch the XL (least-squares refinement) program (Figure 6-38).

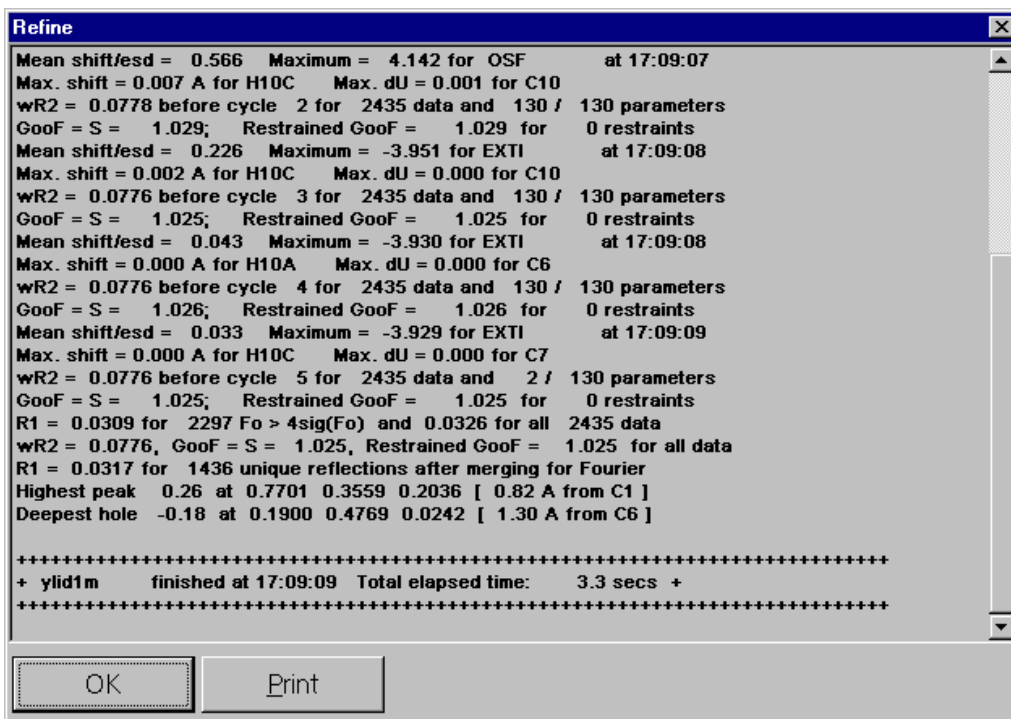

Figure 6-38. Least-squares refinement

In the output above, note that the R1 value is 3.1% and that the goodness-of-fit (GooF) value is now 1.026. We have carried out a complete refinement of suitable quality for publication. This is typical for a final anisotropic refinement with H atoms included.

46. Click OK to return to XSHELL.
47. To display the thermal ellipsoids for the final structure, click on the background with the right mouse button and select Thermal Ellipsoids (Figure 6-39).

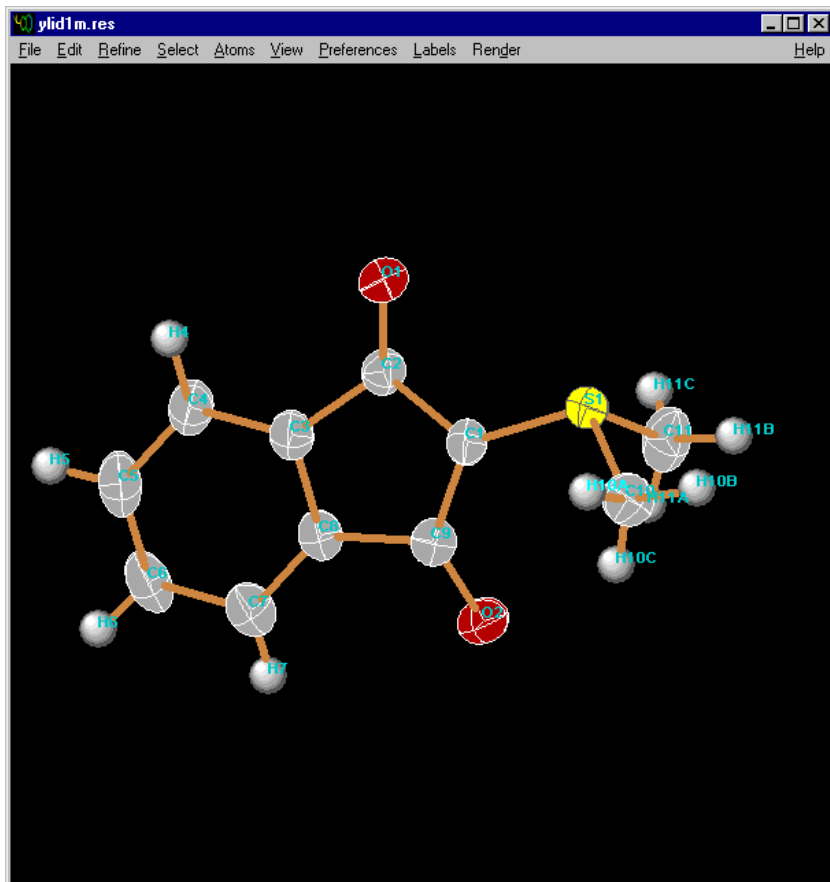

Figure 6-39. Thermal Ellipsoids